

Instruction Manual

Sailor™

Single Channel Pipettes



epr®

Table of Contents

1. Product Description	1
2. Packing.....	1
3. Pipette Design.....	2
4. Safety Recommendations	3
5. Specifications	4
6. Pipette Operation	5
7. Operating Instructions	8
8. Aspiration and Dispensing Instructions.....	9
9. Checking Pipetting Accuracy Parameters and Pipette Recalibration	11
10. Pipette Maintenance	14
11. Troubleshooting	15
12. Spare Parts.....	17
13. Limited Warranty	19

1. Product Description

The EPRO® Sailor™ single channel pipette is a volumetric instrument designed to measure and transfer liquids precisely and safely. It is available in volumes from 0.1 µL to 1,000 µL in five volume ranges: 0.1-2 µL, 0.5-10 µL, 2-20 µL, 20-200 µL, and 100-1,000 µL.

The EPRO® Sailor™ pipettes are available in three versions which differ in the color of the ejector bush, pushbutton, and shaft (red, yellow, and blue), depending on the volume range of the pipettes and corresponding tip size.

Nominal Volume (µL)	Cat. No.	Range of Pipette Volumes (µL)	Color Code
2	EPS2	0.1 - 2	Red
10	EPS10	0.5 - 10	
20	EPS20	2 - 20	Yellow
200	EPS200	20 - 200	
1,000	EPS1000	100 - 1,000	Blue

The EPRO® Sailor™ pipettes operate using an air-cushion (i.e., the aspirated liquid does not come into contact with the shaft or plunger of the pipette). The liquid is drawn into the disposable tip attached to the pipette.

2. Packing

The pipettes are delivered with the following:

Description	Qty/Pk
Instruction manual (QR code)	1
Quality Control certificate	1
Calibration key	1
Wall mount	1
Lubricant (for single channel pipettes)	1
Ejector cap (for pipette models EPS2 and EPS10)	1
Color identification rings	6

Starter Kit

The EPRO® Sailor™ Pack (Cat. No. EPS2.20.200.1000) comes with four individually boxed pipettes (EPS2, EPS20, EPS200, and EPS1000) containing the packing items listed above, a 4-position plexi stand, and EPROTIPS™.

3. Pipette Design

Model Identification

The pipette shaft comes in red, yellow, and blue depending on the volume range of the pipette. The volume range of the pipette is also displayed on the pushbutton.

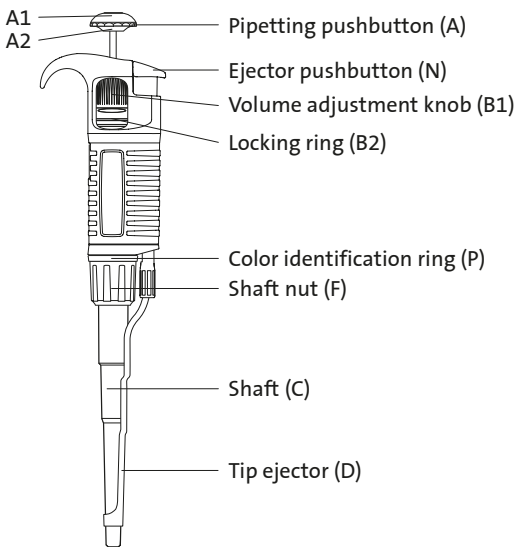

- A. **Pipetting pushbutton:** Consists of 2 parts: the pushbutton (A1) and the knob (A2).
- B1. **Volume adjustment knob:** Used to set the volume.
- B2. **Locking ring:** Allows the volume setting to be locked by pushing the ring upwards.
- C. **Shaft:** Manufactured using high quality plastic, ensuring high chemical and mechanical strength.
- D. **Tip ejector**
- F. **Shaft nut**
- N. **Ejector pushbutton**
- P. **Color identification ring**

4. Safety Recommendations

Long-term use of the pipette relies on correct method of use. Please read and follow the instructions for use carefully.

Symbols used:



Danger, risk of injury.

NOTE

Risk of damage to the pipette or errors in pipetting.

NOTE:

- The pipette is designed for the transfer of liquids only using the tip. Do not aspirate liquids without the tip attached. The aspirated liquid should not enter the pipette, as it may cause damage.
- Single-use tips reduce the risk of contamination of samples.
- Keep the pipette clean, avoiding the use of abrasive or corrosive cleaning agents (e.g., acetone).
- Keep the pipette upright when there is liquid in the tip.
- Only using the pipette in accordance with the manufacturer's instructions ensures the correct pipette parameters are maintained.
- After replacing the plunger or the shaft, the pipette should be calibrated.
- In the case of incorrect operation, the device should be cleaned in accordance with the Instructions for use or transferred to a service point.
- Ambient operating temperature is +5°C to 45°C.
- Ambient storage conditions (in the original packaging during transport and short storage) is -25°C to 55°C.

 When working with the pipette:

- Follow general work safety regulations regarding hazards related to work in the laboratory.
- Take special care when pipetting aggressive substances.
- Use appropriate protective attire (e.g., clothing, goggles, and gloves).
- Avoid pointing the pipette at yourself or others during use.
- Only use parts and accessories recommended by the manufacturer.

5. Specifications

The pipette is a high quality instrument which offers excellent accuracy and precision. The accuracy and precision (repeatability) of the liquid volume depends on the quality of pipette tips used. The values for accuracy and precision shown in the table below were obtained using manufacturer non-filter pipette tips. Those tips are recommended for use to ensure compatibility, accuracy and precision when pipetting. The manufacturer recommends using EPRO® tips.

Nominal Volume (µL)	Volume (µL)	Accuracy (%)	Precision (%)	Non-filter Tips (µL)
2	Min. 0.1	±40.0	≤12.0	10
	0.2	±12.0	≤6.0	
	1	±2.7	≤1.3	
	Max. 2	±1.5	≤0.7	
10	Min. 0.5	±4.0	≤2.8	10
	1.0	±2.5	≤1.8	
	5.0	±1.0	≤0.6	
	Max. 10.0	±0.5	≤0.4	
20	Min. 2	±3.0	≤1.5	200
	10	±1.0	≤0.5	
	Max. 20	±0.8	≤0.3	
200	Min. 20	±1.2	≤0.60	200
	100	±0.8	≤0.25	
	Max. 200	±0.6	≤0.20	
1,000	Min. 100	±1.6	≤0.40	1,000
	500	±0.7	≤0.20	
	Max. 1,000	±0.6	≤0.15	

The accuracy and precision were obtained gravimetrically using manufacturer tips performing at least 10 measurements of distilled water at a temperature of 20°C ± 1°C according to EN ISO 8655 standards.

The use of tips from other manufacturers or filter tips may result in incorrect liquid aspiration and require pipette recalibration.

The design of the pipette enables the user to recalibrate it according to the information presented in Section 9.

6. Pipette Operation

Attaching the Tips

- Attach the correct tip corresponding to the model number displayed on the pipette pushbutton (Section 5).
- Position the pipette vertically when attaching tips.
- Push the pipette tip on firmly using a slight twisting motion to ensure an airtight seal.

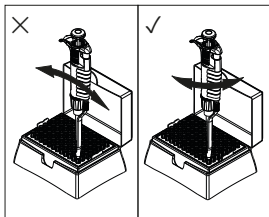

NOTE:

- Do not attach the tips with a rocking movement, as this may damage the shaft or plunger. **Observe this rule particularly with single channel pipettes of low volume range.**
- Never draw liquids directly into the pipette without the tip attached.

Adjusting the tip ejector

The tip ejector can be adjusted by the user and can accommodate most types of tips available on the market. When using narrow tubes, it may be necessary to remove the tip ejector.

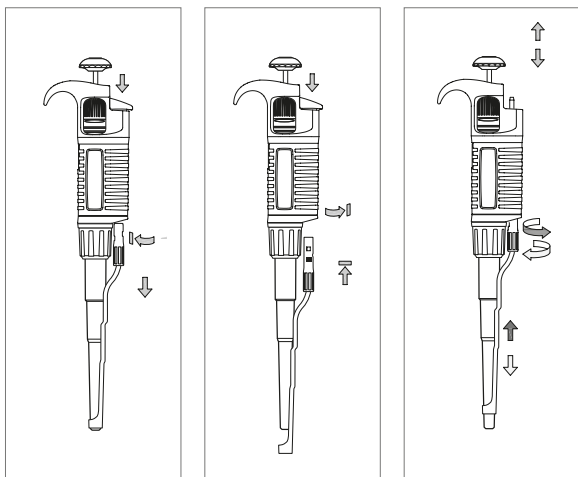

1. Tip ejector disassembly

- Press the tip ejector pushbutton.
- Turn the metal tip ejector 1/3 turn counter-clockwise.
- Slide the ejector from the plastic arbor.

2. Tip ejector assembly

- Press the tip ejector pushbutton.
- Line the metal tip ejector up with the plastic arbor.
- Turn the metal tip ejector clockwise until it has fully latched.

3. Tip ejector adjustment

- Remove the tip ejector pushbutton.
- To increase the ejector length turn the plastic bush counter-clockwise.
- To decrease the ejector length turn the plastic bush clockwise.

If the tip ejector cannot be adjusted sufficiently, or if the diameter of the ejector is insufficient to eject the tip, it may be necessary to attach the ejector cap “M” to the ejector.

For 2 and 10 μL pipettes place the cap, supplied with the pipette, on the bottom of the pipette shaft and slide the cap upwards to the bottom of the tip ejector.

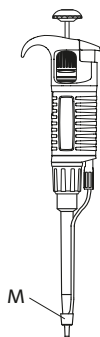

Volume Setting

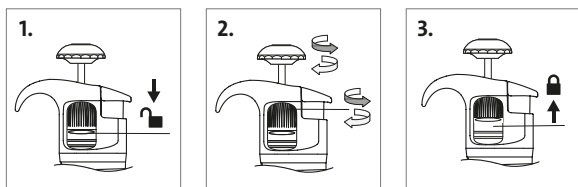

1. To enable volume selection, set the locking ring to the lower position.
2. Aspiration volume can be set by either turning the pipetting pushbutton knob, or the adjustment knob. The volume setting is displayed as a three digit counter, which should be read from top to bottom. The smallest volume increment is printed on the bottom counter drum.
3. After the volume has been set, set the locking ring to the upper position to avoid inadvertent changing of volume.

Examples of counter indications

The decimal point in the volume of aspirated liquid (μL or mL) is indicated by change in colour of digits. Black digits represent integer numbers, and red digits represent decimal fractions (pipettes up to 20 μL).

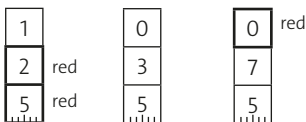

Volume Ranges	0.1-2 μL	20-200 μL	100-1,000 μL
Set Volume	1.25 μL	35 μL	750 μL (0.75 mL)
Increment	0.002 μL	0.2 μL	2.0 μL

For maximum accuracy, the set volume must be approached from a higher value by decreasing counter readings. Before reaching the desired value, reduce the speed of turning the adjustment knob to avoid inadvertently exceeding the desired value.

7. Operating Instructions

Observing the following recommendations will ensure maximum possible accuracy and precision of liquid sampling.

- During operation, the volume setting should be locked, with black adjustment knob in the lower position.
- Ensure smooth and slow operation of the pipette.
- Immersion of the tip into the sample liquid should be kept to a minimum depth, which should remain constant during aspiration. The recommended immersion depths are given in the table below:

Model Volume Range (μL)	Immersion Depth (mm)
0.1-1	≤ 1
1-100	2-3
101-1,000	2-4

- The pipette should be held in a vertical position.
- The pipette tip should be changed whenever the volume setting is altered, and when a different liquid is to be aspirated.
- The pipette tip should be changed if a droplet remains on the end of the tip from the previous pipetting operation.
- Each new pipette tip should be pre-rinsed with the liquid to be pipetted.
- Liquid should never enter the pipette shaft. To prevent this:
 - Press and release the pushbutton slowly and smoothly.
 - Never turn the pipette upside down.
 - Never lay the pipette on its side when there is liquid in the tip.
- Never force the volume setting beyond the recommended limits.

- When pipetting liquids with a different temperature from the ambient temperature, it is recommended to pre-rinse the tip several times prior to use.
- Do not pipette liquids with temperatures above 70°C.

NOTE: When pipetting acids or corrosive solutions which emit vapors, it is recommended to disassemble the shaft and rinse the plunger and O-ring with distilled water after finishing the pipetting operation.

8. Aspiration and Dispensing Instructions

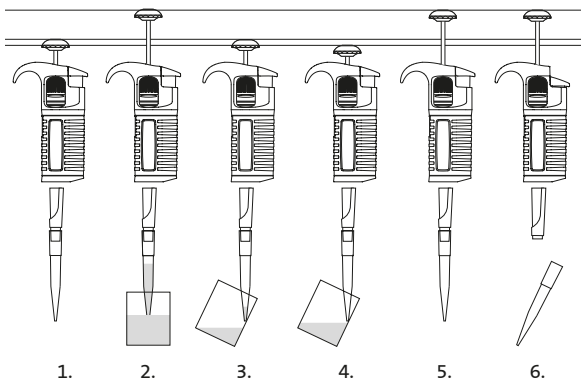

Aspirating Liquid

1. Press the pushbutton to the first stop point.
Holding the pipette vertically, immerse the pipette tip into the sample liquid to the recommended depth (for recommended values see Section 7). If the pipette tip is not immersed to the recommended depth or if the pipetting pushbutton is rapidly released, air may enter the pipette tip.
2. Release the pipetting pushbutton slowly and smoothly to aspirate the sample. Wait one second and then withdraw the pipette tip from the liquid.

CAUTION: Do not touch the used tip.

Dispensing Liquid

3. Place the end of the pipette tip against the inside wall of the vessel at an angle of 10° to 40° . Press the pushbutton smoothly to the first stop. Wait one second.
4. Press the pushbutton to the second stop to expel any remaining liquid. While keeping the pushbutton depressed, remove the pipette from the vessel by drawing the pipette tip against the inside surface of the vessel.
5. Release the pushbutton to its starting position.
6. Eject the pipette tip by pressing the tip ejector pushbutton.

 Remember to change the pipette tip whenever a different type of liquid is to be sampled.

Aspirating High-density Liquids

When pipetting liquids of higher viscosity or lower surface tension than water (e.g., sera or organic solvents), a film of liquid may be formed on the inside of the pipette tip which may produce erroneous results. As the film remains relatively constant in successive pipetting operations with the same tip, this error can be eliminated by pre-rinsing the tip and allowing a film to form before transferring the first sample. This is achieved by aspirating a sample and dispensing it back into the same vessel. Allowing a film to form prior to sampling ensures optimal accuracy and repeatability.

This pre-rinsing operation should be repeated when the volume to be aspirated is changed or when a new pipette tip is used.

NOTE: Normally the degree of error resulting from viscous liquids is negligible if pipetting is performed slowly and carefully, however can be minimized further by holding the pipette tip in position for at least 2 seconds after aspiration to allow the liquid time to react to the change in pressure before it is dispensed.

If the above method does not result in accurate values, recalibrate the pipette in accordance with Section 9.

It is recommended to record recalibration and correction values, in order to facilitate reverse calibration to a standard liquid.

9. Checking Pipetting Accuracy Parameters and Pipette Recalibration

The EPRO® Sailor™ pipettes have been factory-calibrated using gravimetric methods with manufacturer pipette tips and distilled water, in accordance with ISO 8655 guidelines for the maximum (nominal) liquid volume drawn by the pipette and for 10% of the maximum or minimum liquid volume according to the values given (Section 5).

The EPRO® Sailor™ pipettes are designed to enable recalibration and adaptation to different pipetting techniques and liquid properties (e.g., temperature, density, and viscosity).

Periodic checks of the operation of the pipette are recommended at least once per year. Frequency of checks should be increased depending on workload, sterilization or autoclave processes, and frequency of replacement of component parts.

If during pipette operation the accuracy error (the difference between the real aspirated volume and the preset volume) exceeds the permissible value given in the table in Section 5, pipette recalibration should be carried out.

Recalibration of the pipette involves volume adjustment based on the value obtained by weighing. Recalibration of the pipette is performed only for one liquid volume drawn by the pipette.

The recommended volume for recalibration is 10% of the maximum (nominal) value or minimum volume depending on which of these values is greater. See table on page 13 for more details.

Parameters for Checking the Pipetting Accuracy

The pipetting accuracy is influenced by factors such as: tips used, characteristics of the pipetted liquid (density, viscosity), and operating conditions (ambient temperature, pressure).

To determine the accuracy error of the pipette, the following conditions should be met:

- Ambient temperature and temperature of the pipette, pipette tips, and liquid should be within the range of 20°C to 25°C and stabilized during weighing within $\pm 0.5^\circ\text{C}$.
- Measurements should be conducted using distilled water.
- Balance sensitivity should be suitable for the volume “V” to be measured.

Volume Checked (V, μL)	Balance Sensitivity (mg)
$0.1 \leq V \leq 10$	0.001
$10 \leq V \leq 100$	0.01
$100 \leq V \leq 1,000$	0.1

- When calculating the liquid volume aspirated by the pipette, the conversion factor (Z) [$\mu\text{L}/\text{mg}$] for distilled water or a liquid with comparable density should be taken into account. Sample values of conversion factors are given in the following table.

Temperature ($^\circ\text{C}$)	Pressure (kPa)		
	95.0	101.3	105.0
20	1.0028	1.0029	1.0029
21	1.0030	1.0031	1.0031
22	1.0032	1.0033	1.0033
23	1.0034	1.0035	1.0036
24	1.0037	1.0038	1.0038
25	1.0039	1.0040	1.0040

See ISO 8655 for the full table of conversion factors (Z).

NOTE: Pipetting should be performed in accordance with guidance described in Sections 7 and 8.

Checking the Pipetting Accuracy Parameters

- Set the preset volume depending on the pipette volume according to the following table.

Nominal volume (μL)	Preset volume (μL)	Permissible values (μL)	Volume Change ΔV (μL) for a Turn of a Calibration Key by	
			1 Turn	1 Increment
2	0.2	0.176 - 0.224	0.06	0.0025
10	1	0.975 - 1.025	0.33	0.0137
20	2	1.94 - 2.06	0.63	0.0262
200	20	19.76 - 20.24	6.30	0.262
1,000	100	98.4 - 101.6	25.00	1.04

- Perform 10 aspirations, and calculate the average value in [mg].
- Calculate the volume in [μL] by multiplying the value in [mg] by the conversion factor Z [μL/mg].

If the average aspirated volume exceeds the permissible values of the range, the pipette should be recalibrated.

Pipette Recalibration

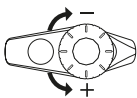
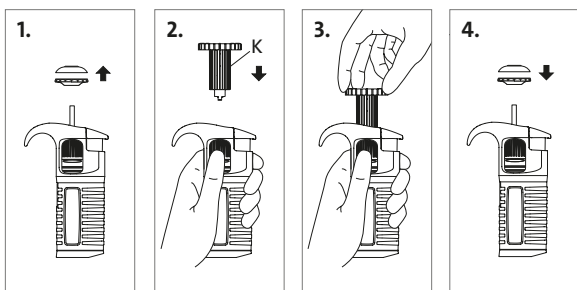

1. Remove the pipetting pushbutton.
CAUTION: The pipetting pushbutton consists of 2 parts: the knob and the pushbutton. After removal of the pushbutton, both parts are separated.
2. Holding the volume setting knob to prevent rotation, insert the calibration key into the calibration screw.
3. Turn the key clockwise to reduce the aspirated volume, or counter-clockwise to increase the aspirated volume. Use the values given in the above table to precisely adjust the volume.

4. Remove the key and replace the pipetting pushbutton by first replacing the knob, then the pushbutton.

Determine the average aspirated volume. The average volume should be within the permissible range given in the table. If the volume exceeds the values stated, the recalibration procedure should be repeated.

When pipetting liquids with physical properties considerably different from those of water, follow the guidance given in Section 5.

More information on the calibration procedure can be found at www.eproscience.com and <https://shop.eproscience.com>.

10. Pipette Maintenance

Depending on the applications and intensity of use, the EPRO® Sailor™ pipette requires periodic maintenance. The components exposed to corrosive vapors, such as shaft elements, should be regularly checked and cleaned.

 Do not use sharp tools for pipette maintenance. It may cause damage to the device and affect the user's safety.

Cleaning

External surfaces of the pipette such as the pushbutton, ejector pushbutton, handgrip, shaft nut, and adjustment knob may be cleaned using a cloth dampened in isopropyl alcohol. The remaining parts removed from the pipette during pipette disassembly may be washed with distilled water or isopropyl alcohol.

NOTE: Before using cleaning agents other than those recommended by the manufacturer, check the compatibility charts and consider chemical resistance of the following plastics which form components of the pipette: PP, PC, POM, PA, PPS, PVDF.

Sterilization

Sterilization using an autoclave

The EPRO® Sailor™ pipettes can be sterilized in an autoclave at 121°C for 20 minutes. Sterilization under other conditions may cause damage to the pipette. It is recommended to:

- Unscrew the shaft nut slightly. Prior to autoclaving, and once autoclaving is finished, the nut should be screwed tight again.

- Set the locking ring to the lower (unlocked) position prior to sterilization.
- Sterilize the pipettes using an autoclave with an initial vacuum and drying cycle.
- After sterilization, the pipette should be dried and cooled to room temperature.

Precision and accuracy should not alter if the pipetting processes including autoclaving are carried out as described in this manual. If a change in accuracy occurs, it is recommended to:

- Check the calibration of the pipette after the first, third, and fifth autoclaving cycles and then after every 10 autoclaving cycles.

Ultra Violet (UV) Sterilization

The EPRO® Sailor™ pipettes are UV resistant. The distance from the radiation source to the exposed element of the pipette should be at least 50 cm. Prolonged or intense UV exposure can cause discoloration of pipette parts but does not affect its performance.

11. Troubleshooting

If a problem is encountered during pipette operation, use the following table to identify and eliminate the fault following the instructions provided. Replacement of parts should be required only occasionally and should not be required with normal pipette use.

Problem	Cause	Solution
Droplets of liquid remain in the pipette tip.	The pipette tip is emptied too fast.	Decrease the speed of pressing the pipette pushbutton.
	The pipette tip wettability has increased due to extensive use.	Replace the tip with a new one.
Droplets of air appear in the liquid aspirated into the pipette tip.	The pipette tip immersion depth is too shallow.	Immerse the tip to the recommended depth according to the instructions.
	The pipette tip is incorrectly pressed onto the pipette shaft.	Press the pipette tip firmly onto the pipette.
	The tip is damaged or worn out due to extensive use.	Replace the tip with a new one.

Problem	Cause	Solution
	The pipette tip is incorrectly pressed onto the pipette shaft.	Press the pipette tip firmly onto the pipette.
The pipette incorrectly aspirates the liquid or the liquid drops out from the tip.	The shaft surface is damaged or contaminated at the sealing site.	Clean the shaft or replace it with a new one.
	The plunger or the O-ring is damaged due to prolonged aspiration of corrosive liquids.	Disassemble the shaft set; wash the shaft, the plunger and the seal (Section 10: Cleaning). Replace the elements with new ones if necessary.
	The inside of the pipette is contaminated.	Apply a small amount of lubricant onto the plunger and reassemble the set in the correct order.
	The sealing elements are not sufficiently lubricated.	
Uneven work of the pipetting set, the pipetting pushbutton gets blocked.	The inside of the pipette is contaminated due to aspiration of corrosive substances.	Unscrew the shaft set, wash the parts. Replace the elements with new ones if necessary. Apply a small amount of lubricant on the plunger and reassemble the set in the correct order.
	The inside of the pipette is contaminated due to the liquid entering the pipette.	
	The sealing elements are not sufficiently lubricated, e.g. after repeated autoclaving procedures.	
Incorrect aspiration.	Liquid with properties other than water (density, viscosity).	Calibrate the pipette using the liquid which is to be pipetted.
	Tips with a filter with increased flow resistance.	Calibrate the pipette using the tips which are to be used for pipetting.

If the problem persists after carrying out the above steps, contact our regional representative.

Before returning the pipette, please ensure the pipette is completely free of any chemical, radioactive, or microbiological contamination which could pose a threat during transport and repair.

12. Spare Parts

Contact our Customer Service to inquire about the availability of spare parts. Pipette model and name of the part required should be specified. The most common parts are depicted below.

NOTE: The replacement of the plunger requires conducting the calibration procedure according to Section 9.

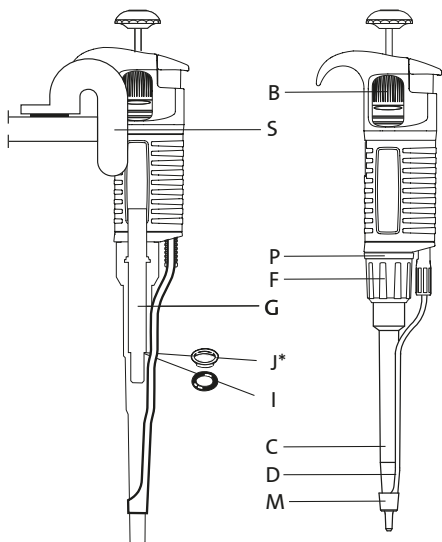

*Seal (J) used only in 2 μ L model

Item	Description	Model	Cat. No.	Qty/Pk
B	Volume adjustment knob set	All	ESP20221	1
C, I, J*	Shaft with O-ring and seal	2	ESP20222	1
		10	ESP20223	1
		20	ESP20224	1
		200	ESP20225	1
		1,000	ESP20226	1
D	Tip ejector	2, 10	ESP20211	1
		20	ESP20212	1
		200	ESP20213	1
		1,000	ESP20214	1

Item	Description	Model	Cat. No.	Qty/Pk
F	Shaft nut	All	ESP20210	1
G	Plunger assembly	2	ESP20215	1
		10	ESP20216	1
		20	ESP20217	1
		200	ESP20218	1
		1,000	ESP20219	1
I, J*	O-ring (and seal)	2	ESP20227	10
		10	ESP20228	10
		20	ESP20229	10
		200	ESP20220	10
		1,000	ESP20230	10
K	Calibration key	All	ESP20231	1
M	Tip ejector cap	2, 10	ESP20232	3
P	Color identification rings	All	ESP20233	6
S	Wall mount	All	ESP20234	1

*Seal (J) used only in 2 μ L model

13. Limited Warranty

Efficiency Progress Research Omics (EPRO®) warrants that this product will be free from defects in material and workmanship for a period of three (3) years from date of purchase. EPRO® DISCLAIMS ALL OTHER WARRANTIES WHETHER EXPRESSED OR IMPLIED, INCLUDING ANY IMPLIED WARRANTIES OF MERCHANTABILITY OR OF FITNESS FOR A PARTICULAR PURPOSE. EPRO®'s sole obligation shall be to repair or replace, at its option, any product or part thereof that proves defective in material or workmanship within the warranty period, provided the purchaser notifies EPRO® of any such defect. EPRO® is not liable for any incidental or consequential damages, commercial loss or any other damages from the use of this product.

This warranty is valid only if the product is used for its intended purpose and within the guidelines specified in the supplied instructions manual. This warranty does not cover damage caused by accident, neglect, misuse, improper service, natural forces or other causes not arising from defects in the original material workmanship. This warranty does not cover the O-ring, or shaft. Claims for transit damage should be filed with the transportation carrier.

In the event this product fails within the specified period of time because of a defect in material or workmanship, contact EPRO® Customer Service at: **tenders@eprosience.com**, visit **www.eprosience.com**, or contact your local support office.

EPRO® Customer Service will help arrange local service where available or coordinate a return authorization number and shipping instructions. Products received without proper authorization will be returned. All items returned for service should be sent using prepaid postage in the original packaging or other suitable carton, padded to avoid damage. EPRO® will not be responsible for damage incurred by improper packaging. EPRO® may elect for onsite service for larger equipment.

Some states do not allow limitation on the length of implied warranties or exclusion or limitation of incidental or consequential damages. This warranty gives you specific legal rights. You may have other rights which vary from state to state.

No individual may accept for, or on behalf of EPRO®, any other obligation of liability, or extend the period of this warranty.

For your reference, make a note of the model number, serial number, date of purchase, and supplier here.

Model No. _____

Serial No. _____

Date Purchased _____

Supplier _____

Warranty/Disclaimer: Unless otherwise specified, all products are for research use only. Not intended for use in diagnostic or therapeutic procedures. EPRO® makes no claims regarding the performance of these products for clinical or diagnostic applications.

This manual is available in other languages at <https://shop.eproscience.com>.

Product availability may vary per region.

For additional product information or technical information, visit www.eproscience.com or contact your local sales office.

EUROPE

office@eproscience.com

+48 797 866 390

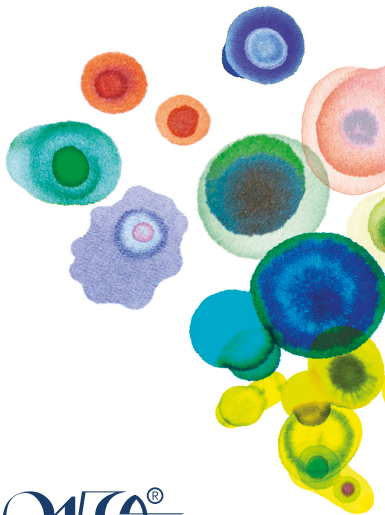

EPRO® Ewa Magdalena Lach

Geodetow 23

84-120 Wladyslawowo

Poland

+48 665 208 800

+48 535 774 222

www.eproscience.com

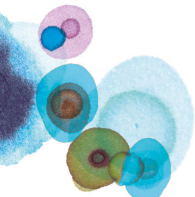

© 2021 EPRO®. All rights reserved.
11/21 EPRO-AN-1000DOC REV2

Made in Poland

For a listing of trademarks, visit www.eproscience.com.
All other trademarks are the property of their respective owners.