

ibidi Application Guide

# Microscopy With the ibidi Chambers

## The Principle of Imaging Chambers: The Coverslip Bottom . . . . . 2

Fun Fact: Why So Many ibidi Products Have a “μ” in Their Names . . . . . 2

ibidi Polymer Coverslip. . . . . 3

Glass Coverslip Bottom . . . . . 3

Immersion Oil Compatibility of ibidi Labware . . . . . 3

## The Surfaces of the ibidi Chambers: Choose the Ideal Solution for Your Assay 4

ibiTreat . . . . . 4

Hydrophobic, Uncoated . . . . . 4

Bioinert. . . . . 4

Glass. . . . . 4

Coatings: Collagen I, Collagen IV, and Poly-L-Lysine. 5

Elastically Supported Surface (ESS). . . . . 5

## The Geometry of the ibidi Chambers: Optimized for Your Application. . . . . 6

Chamber Geometry . . . . . 6

All-In-One Chambers: All Steps in One Single Slide . 6

Channel Slides: Homogenous Cell Growth and Optimized Phase Contrast Microscopy . . . . . 8

Ph+ Slides: Excellent Meniscus-Free Phase Contrast Microscopy . . . . . 9

## Microscopy Parameters of Different Surfaces . . . . . 10

Microscopy Parameters of Different Materials . 10

Coverslip Thickness . . . . . 10

Numerical Aperture . . . . . 10

Refractive Index . . . . . 11

Material Dispersion / Abbe Number. . . . . 11

Transmission. . . . . 11

Autofluorescence . . . . . 11

## Microscopy Techniques and Culture Surfaces: Find the Perfect Match . . . 12

Compatibility of Different Surfaces With Light Microscopy Techniques . . . . . 12

Inverted Microscopy. . . . . 13

Upright Microscopy . . . . . 13

Phase Contrast . . . . . 14

Differential Interference Contrast (DIC) . . . . . 16

Widefield Fluorescence Microscopy . . . . . 17

Confocal Microscopy . . . . . 18

Two-Photon and Multiphoton Microscopy. . . . . 19

Fluorescence Recovery After Photobleaching (FRAP) . . . . . 20

Light Sheet Fluorescence Microscopy (LSFM) . 20

Förster Resonance Energy Transfer (FRET). . . . . 21

Fluorescence Lifetime Imaging Microscopy (FLIM). 21

Total Internal Reflection Fluorescence (TIRF) . . 22

Super-Resolution Microscopy (STED, SIM, (F)PALM, (d)STORM) . . . . . 23

## The Principle of Imaging Chambers: The Coverslip Bottom

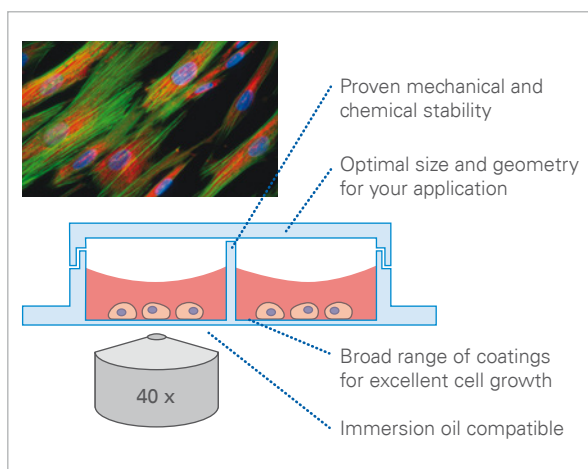

The outstanding characteristic of the ibidi [μ-Slides](#), [μ-Dishes](#), and [μ-Plates](#) is their thin coverslip bottom, which has excellent features for high-end microscopy applications. In comparison, the bottom of standard cell culture plastics is about 1 mm thick—which is more than 5 times the thickness of the coverslip and therefore not ideal for imaging.

ibidi offers labware with the ibidi Polymer Coverslip bottom or the ibidi Glass Coverslip bottom. For most applications, the ibidi Polymer Coverslip is the material of choice, as it offers optimal cell adherence combined with excellent optical properties. If your cells require a special coating, or if you are using a particular microscopy technique such as [TIRF](#) or super-resolution microscopy ([STED](#), [STORM](#)), we recommend using the ibidi Glass Coverslip bottom.

Imaging chambers with the coverslip bottom are optimized mainly for use with inverted microscopy. You can find information about the compatibility of the surface materials with different microscopy techniques in the chapter "[Microscopy Techniques and Culture Surfaces: Find the Perfect Match](#)".

	#1.5 ibidi Polymer Coverslip	#1.5H ibidi Glass Coverslip	#1.5 glass coverslip	Standard glass slide*
Bottom thickness	180 μm (+10/-5 μm)	170 μm (+/-5 μm)	170 μm (+20/-10 μm)	1 mm
Bottom material	Polymer	D 263 M Schott high precision glass	D 263 M Schott high precision glass	Glass
Gas permeability	Yes	No	No	No

\* The ibidi [3 Well / 8 Well / 12 Well Chamber Slides, removable](#) are self-adhesive, removable silicone chambers that are mounted on a standard glass slide. They are suitable for upright and inverted microscopy and enable long-term storage of samples after immunofluorescence staining.

### Fun Fact: Why So Many ibidi Products Have a "μ" in Their Names

μ is a lowercase letter in the Greek alphabet ("Mu"). In the metric system, the unit prefix "μ" is used as a symbol for "micro" and represents one millionth (10<sup>-6</sup>).

Here are some reasons why the μ found its way into so many ibidi product names:

- Typically, eukaryotic cells are 10–100 micrometers in diameter.
- To put the cells into focus, we offer solutions for different microscopy techniques.
- The principle of the ibidi μ-Slides, μ-Dishes, and μ-Plates is the thin coverslip bottom with a thickness of 180 micrometers.
- Last, but not least, our physicists love to use Greek letters such as "μ".

## ibidi Polymer Coverslip

The ibidi Polymer Coverslip, which is our most recommended surface, is a thin plastic coverslip that forms the bottom of most [μ-Slides](#), [μ-Dishes](#), and [μ-Plates](#). With a standard No. 1.5 coverslip thickness of 180 μm (+10/-5 μm) and immersion oil compatibility, it meets all optical requirements for microscopes and is suitable for various imaging techniques. Due to the gas-permeable material of the ibidi Polymer Coverslip, carbon dioxide or oxygen exchange during cell culture is maintained. The ibidi Polymer Coverslip provides optimal growth conditions for various cell-based assays and cell types and is available with different treatments or coatings (ibiTreat, Bioinert, Collagen IV, Poly-L-Lysine). You can find more information about the coatings in the chapter "[The Surfaces of the ibidi Chambers](#)".

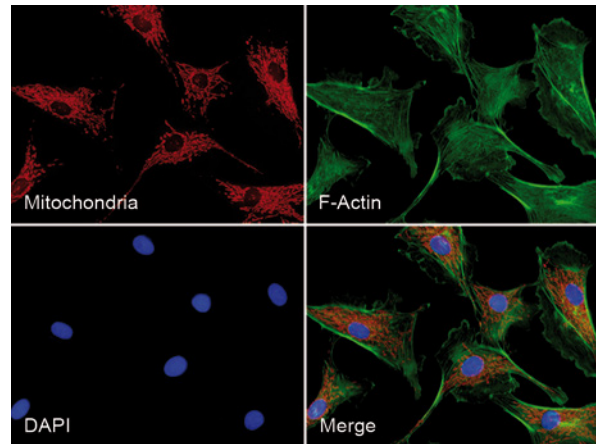

Triple immunofluorescence of bovine endothelial cells  
Red: mitochondria, stained with MitoTracker™ Red CMXRos;  
Green: F-actin, stained with Alexa Fluor™ 488 Phalloidin;  
Blue: nuclei, stained with DAPI.

## Glass Coverslip Bottom

ibidi offers specialized glass bottom labware with a borosilicate coverglass bottom. ibidi developed these glass surfaces specifically for [TIRF](#), [super-resolution microscopy](#), and single molecule microscopy. The glass bottoms are completely gas-proof and do not allow for any gas exchange.

To provide the highest quality necessary for modern, high-performance microscope objectives, only D 263 M Schott glass coverslips with a thickness range of 170 μm (+/-5 μm) are used. This thickness is also known as #1.5H (high performance).

*Please note: In principle, glass bottoms are suitable for direct cell culture. However, to promote cell attachment, a surface coating might be required prior to cell seeding.*

## Immersion Oil Compatibility of ibidi Labware

Oil immersion is used to increase the resolution of the objective, up to its physical limit. Placing immersion oil instead of air between the objective lens and the coverslip allows for a significantly higher amount of light to be collected by the lens. This, in turn, increases the resolution and the signal-to-noise ratio in microscopic images.

For high-resolution microscopy, cell culture chambers need to be compatible with immersion oil. All ibidi μ-Slides, μ-Dishes, and μ-Plates are compatible with a variety of commonly used immersion oils.

[Visit our website](#) to find out which immersion oils are compatible with ibidi products.

The ibidi glass bottom labware is available in the following formats:

- [μ-Dish<sup>35 mm, high</sup> Glass Bottom](#)
- [μ-Slide VI<sup>0.5</sup> Glass Bottom](#)
- [μ-Slide 2 Well | 4 Well | 8 Well Glass Bottom](#)
- [μ-Slide 2 Well<sup>Ph+</sup> | 4 Well<sup>Ph+</sup> Glass Bottom](#)

The ibidi [Glass Bottom Dish<sup>35 mm</sup>](#) is produced by using a standard #1.5 glass coverslip with a thickness of 170 μm (+20 μm/-10 μm). This glass bottom material fulfills the needs of all standard applications where a cost-effective coverslip is required.

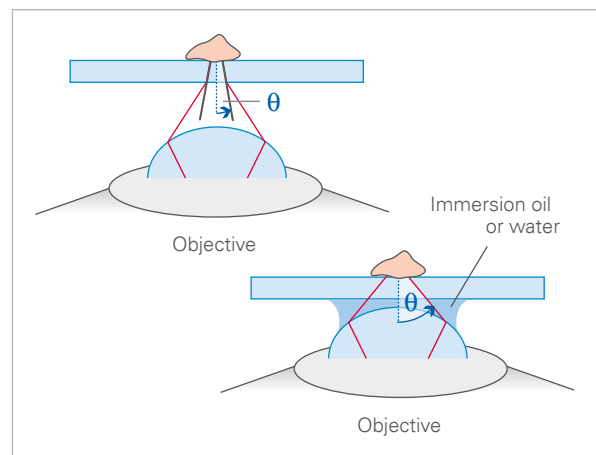

# The Surfaces of the ibidi Chambers: Choose the Ideal Solution for Your Assay

Growth, development, and signaling of cultured cells strongly depend on which surface was used to seed the cells. ibidi offers several surfaces and coatings for different applications.

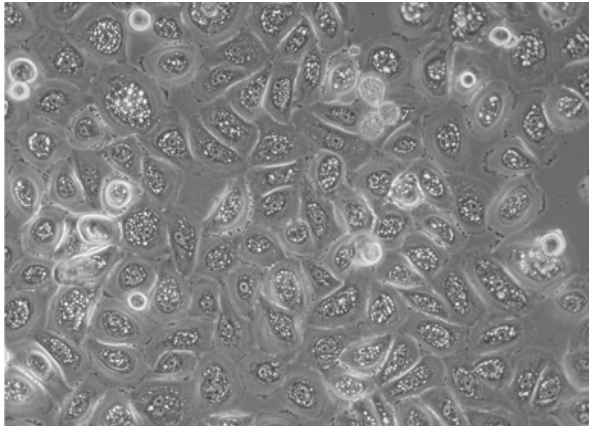

Human primary keratinocytes on the ibiTreat ibidi Polymer Coverslip.

## ibiTreat

### Direct culture of adherent cells; coatings possible

ibiTreat is our most recommended surface modification, because most adherent cells grow well on it without the need for any additional coating. ibiTreat is the hydrophilic, tissue culture-treated version of the ibidi Polymer Coverslip. This physical surface modification, which is comparable to the tissue culture treatment of standard cell culture vessels, makes the surface hydrophilic and adhesive to virtually all cell types. The ibiTreat surface appears in more than 10,000 peer-reviewed publications. The adhesion of cells to ibiTreat  $\mu$ -Slides is even strong enough to perform flow experiments that simulate the physiological shear stress of the blood flow.

## Hydrophobic, Uncoated

### Application of user-specific coatings

The Uncoated surface is a hydrophobic version of the ibidi Polymer Coverslip with identical optical properties. It does not permit direct cell growth without an additional coating. Therefore, it is not suitable for the standard cultivation of adherent cells. Due to its hydrophobicity, it can be used for specific coatings or for non-adherent suspension cells. However, for cells in suspension we recommend using the Bioinert surface.

## Glass

### Application of specific coatings; TIRF or super-resolution microscopy; glass chemistry applications

A large variety of the ibidi labware is available with a glass coverslip bottom. The glass coverslip is suitable for all standard ECM coatings (e.g., collagen, fibronectin, and laminin). The surface also allows for the application of all common glass chemistry modifications, such as silanization, plasma treatments, and chemical activation.

## Bioinert

### Culture of suspension cells and spheroids

The Bioinert surface is a thin polyol hydrogel layer that is covalently bound to the ibidi Polymer Coverslip. This surface inhibits cell-surface interaction and therefore is ideally suited for the culture of suspension cells and spheroids. In contrast to standard ultra-low attachment (ULA) coatings, Bioinert is completely non-adherent and does not allow binding of any biomolecule, even in long-term experiments. Furthermore, the ibidi Polymer Coverslip provides excellent optical properties for high-resolution microscopy. The Bioinert surface is currently available for the [μ-Dish<sup>35 mm, high</sup> Bioinert](#).

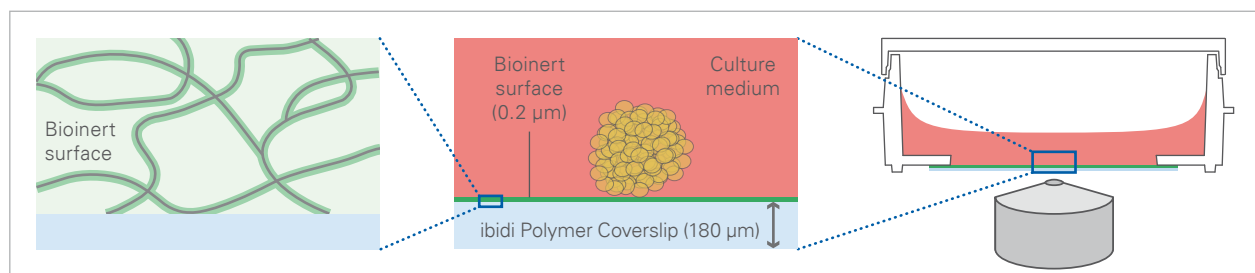

# Coatings: Collagen I, Collagen IV, and Poly-L-Lysine

## Culture of adherent cells that require a specific extracellular matrix (ECM) on the surface

For selected  $\mu$ -Slides, ibidi offers Collagen IV and Poly-L-Lysine precoated surfaces on the ibidi Polymer Coverslip. We also provide a high-quality Collagen Type I, Rat Tail solution for preparing 3D gels and surface coatings.

### Collagen I

Collagen type I is the most common type of collagen in the human body. Building collagen fibers, it is present in many parts of the body, such as skin and bone. To promote better cell adherence, culture vessel surfaces, such as the ibidi Polymer Coverslip, can be coated with collagen I. In addition, collagen I 3D gels are frequently used for cell cultivation to stimulate an *in vivo*-like 3D environment. ibidi provides a high-quality [Collagen Type I, Rat Tail](#) that is made from rat tail tendon.

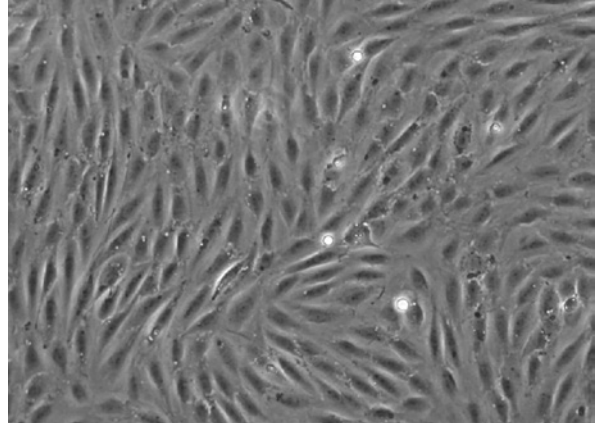

RAT1 cells on the ibidi Polymer Coverslip coated with Collagen IV.

### Collagen IV

Collagen type IV is one of the major constituents of the basement membrane, which is a thin layer of the extracellular matrix (ECM). In cell culture, collagen IV is used as a substrate to promote the adherence and proliferation of cells. Collagen IV coatings have been tested for a variety of standard cell lines, such as epithelial, endothelial, neural, and muscle cells. ibidi uses mouse collagen IV for the coating.

### Poly-L-Lysine (PLL)

Poly-L-lysine (PLL) is a polymer of the essential amino acid L-lysine. This polymer is one of the most commonly used adhesion substrates for cell culture. It is suitable for a large variety of cell types, especially for neuronal cultures. Adhesion is mediated by an integrin-independent mechanism when PLL is used.

## Elastically Supported Surface (ESS)

### Culture of adherent cells on an elastic surface

In living tissue, cell growing conditions are different from those in *in vitro* cultures. The surface stiffness/elasticity affects cell proliferation, differentiation, and overall cellular function. The elasticity (Young's modulus) of most cell culture plastics is  $\sim 1$  gigapascal (GPa). Young's Modulus of glass is  $\sim 70$  GPa. In contrast, the Young's Modulus of mammalian cells is  $< 100$  kPa. Therefore, the natural cell environment is at least 100,000 times more elastic than the standardly applied cell culture surfaces.

The elasticity of the ibidi elastically supported surface (ESS) is comparable to that in cells and tissue. The  [\$\mu\$ -Dish 35 mm, high ESS](#) is available in three different elasticities, which cover the whole range of elasticities found in living tissue.

As the uncoated ESS surface is hydrophobic and does not allow for any direct cell growth, we recommend extracellular matrix coatings.

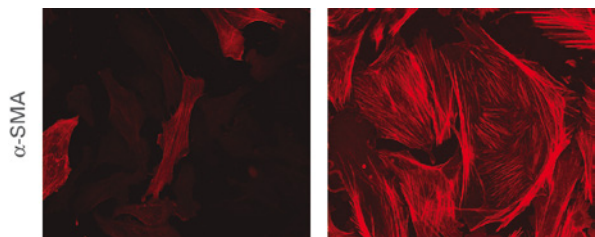

Undifferentiated fibroblasts on regular surfaces.

Differentiated fibroblasts on elastic surfaces (ESS 28 kPa).

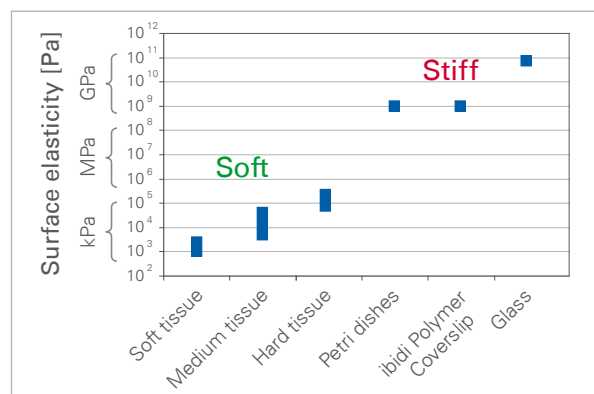

# The Geometry of the ibidi Chambers: Optimized for Your Application

## Chamber Geometry



### Open-Well Format

- Common formats
- Easy handling
- Large or low volume



### Channel Format

- Excellent imaging
- Homogeneous cell distribution
- Low volume



### Specialized Geometry

- Designed for specific uses (e.g., gradients or gel matrices)

Your cell-based assays are as versatile as our chambers: We provide imaging chambers with various geometries that are specifically tailored to your assay. In order to guarantee the highest imaging quality at optimized experimental conditions, we have developed our imaging chambers using a combination of geometrical patterns and physical features. The all-in-one chambers reduce the time and number of experimental steps needed in cell-based assays. In addition, ibidi provides labware with specialized geometrical designs for functional cell-based assays, such as angiogenesis, chemotaxis, wound healing, or cell migration assays.

## All-In-One Chambers: All Steps in One Single Slide

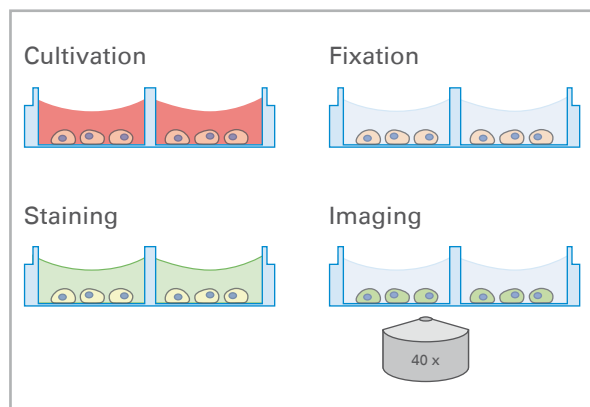

*The ibidi all-in-one chambers reduce the number of experimental steps needed in immunofluorescence assays.*

All-in-one chambers have been developed to optimize the daily lab routine by providing an all-in-one solution for cell cultivation, treatment, and live cell imaging. The design of the ibidi [μ-Slides](#), [μ-Dishes](#), and [μ-Plates](#) allows for all of the experimental steps—from cell cultivation to microscopic imaging—to be conducted in one single chamber.

The open-well format of the [μ-Slide 2 Well](#) | [μ-Slide 4 Well](#) | [μ-Slide 8 Well](#), and the [μ-Dish<sup>35 mm, high</sup>](#) allows for the use of standard immunofluorescence protocols—with all procedures done in one single slide. After fixation and staining, the sample can be observed through the coverslip bottom using high-resolution microscopy. There is no need for an additional glass coverslip.

Channel formats like the [μ-Slide VI<sup>0.4</sup>](#) are ideal for an exact exchange of small amounts of reagents. These μ-Slides reduce the number of experimental steps needed for immunofluorescence assays. Due to the low volume, the channel slides help saving a lot of money for antibodies.

## Excuse: Chamber Slides, Removable

With the [3 Well](#) | [8 Well](#) | [12 Well Chamber Slides, removable](#), ibidi provides self-adhesive, removable silicone chambers that are mounted on a standard glass slide (1 mm thickness). They are suitable for upright and inverted microscopy and enable long-term storage of samples after immunofluorescence staining.

All steps in the immunofluorescence assay can be done in one single slide, which simplifies the overall procedure and requires only a small number of cells and a low amount of antibody and medium.

*Please note: In principle, glass bottoms are suitable for direct cell culture. However, to promote cell attachment, a surface coating might be required prior to cell seeding.*



3 Well | 8 Well | 12 Well Chamber Slides, removable

Removable silicone chambers for cell culture and immunofluorescence, suitable for upright and inverted microscopy.

## Immunofluorescence using the 12 Well Chamber, removable

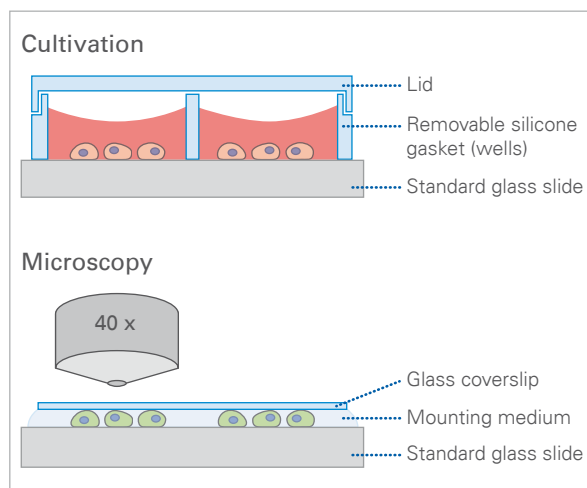
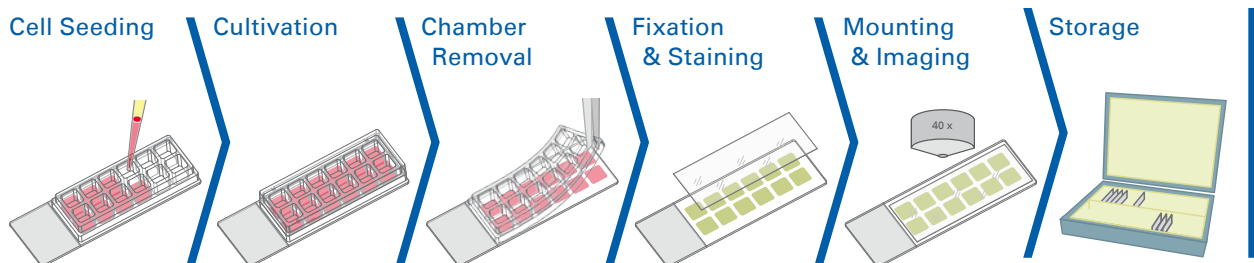

The ibidi Chamber Slides, removable, allow for cell cultivation (top) and upright microscopy of cells (bottom) after immunofluorescence staining.

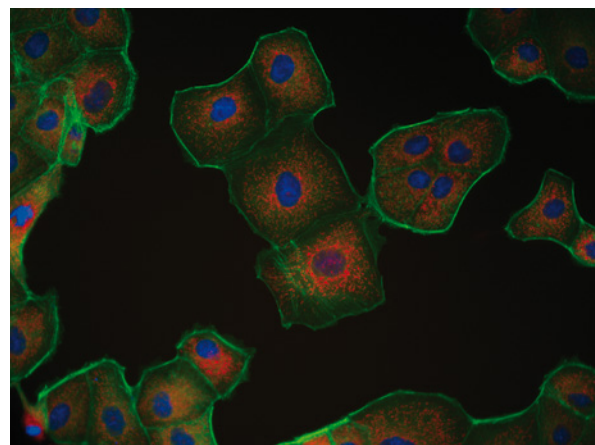

Triple immunofluorescence of Madin-Darby canine kidney (MDCK) cells.  
Red: mitochondria, stained with MitoTracker™ Red CMXRos;  
Green: F-actin, stained with Alexa Fluor™ 488 Phalloidin;  
Blue: nuclei, stained with DAPI.

# Channel Slides: Homogenous Cell Growth and Optimized Phase Contrast Microscopy

## Homogeneous Cell Distribution

In addition to being optimized for cell culture under flow, the ibidi channel slides format provides the ideal geometry for homogeneous cell distribution.

Cell densities in open wells are very dependent on handling during cell seeding. Due to the closed channel geometry, cell densities in channels do not vary depending on their positions inside the slide, or with their handling and treatment during and after cell seeding.

To demonstrate the influence of slide geometry on cell distribution, cultivated cells were visualized macroscopically and microscopically in the open [μ-Slide 8 Well](#) and the channel [μ-Slide VI<sup>0.4</sup>](#), respectively. Macroscopically, the cells cultured in the μ-Slide 8 Well formed characteristic patterns. In general, the cell density in the middle of the well reached its maximum, while fewer cells attached to the outer well regions. Some cells congregated to the edges of the well. In contrast, the cell distribution in the [μ-Slide VI<sup>0.4</sup>](#) stayed homogeneous. This was confirmed by phase contrast and fluorescence microscopy.

### μ-Slide 8 Well

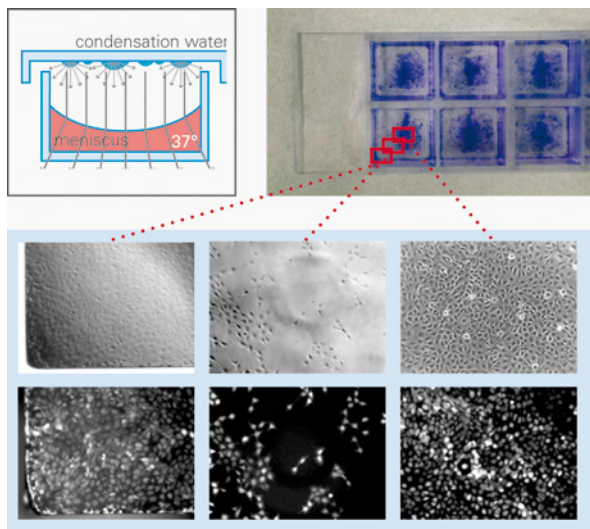

### μ-Slide VI<sup>0.4</sup>

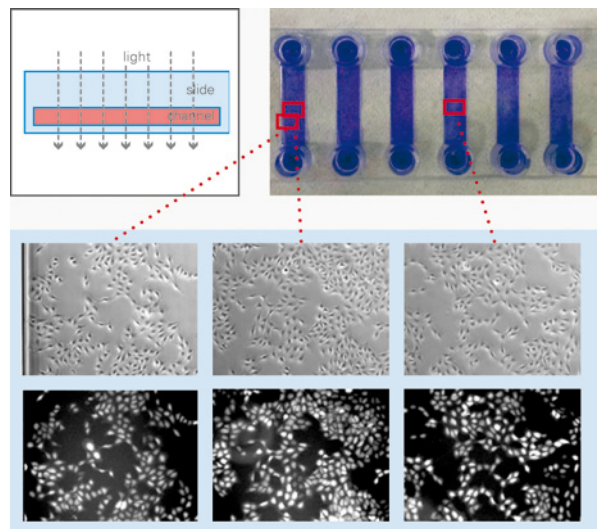

Geometric scheme and cell distribution in the  $\mu$ -Slide 8 Well (left) and the  $\mu$ -Slide VI<sup>0.4</sup> (right). Cells were visualized macroscopically using crystal violet staining (top), and microscopically using phase contrast (middle) and fluorescence microscopy (bottom).

## No Lid—No Condensation

Condensation, which occurs on the lid of the culture vessel after being removed from the incubator, is another effect that disrupts phase contrast microscopy. When using the ibidi [channel slides](#), condensation inside the optical pathway is intrinsically impossible.

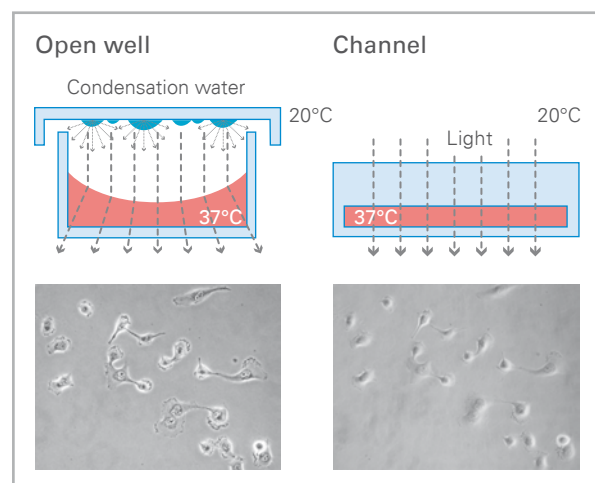



## Optimized Phase Contrast Microscopy

The meniscus formation in open well chambers at the air-water-interphase is a natural and unavoidable effect that can disturb phase contrast microscopy. In channel slides (e.g., the ibidi [μ-Slide VI<sup>0.4</sup>](#)), meniscus formation is geometrically impossible. Therefore, phase contrast in channel slides is superior to small open wells.

Find more detailed information about the principle of phase contrast microscopy and ibidi labware solutions in the chapter "[Microscopy Techniques and Culture Surfaces: Find the Perfect Match](#)".

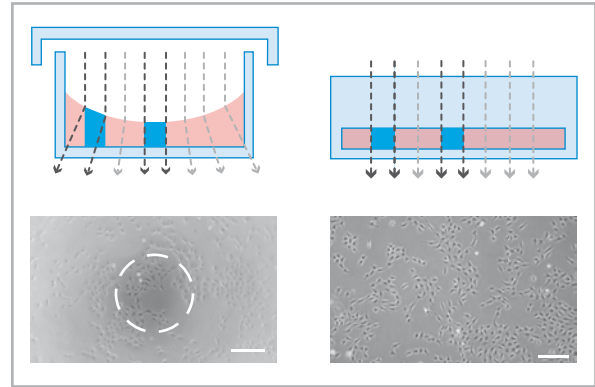

## Ph+ Slides: Excellent Meniscus-Free Phase Contrast Microscopy

The μ-Slides and μ-Dishes with Ph+ feature (Phase Contrast +) are designed for excellent phase contrast microscopy without meniscus, which naturally disturbs the phase contrast effect in standard open wells. The Ph+ version provides a special intermediate plate in the center of the well. This plate flattens the meniscus and creates a parallel beam throughout the plate, thereby increasing the area of well-contrasted cells. Openings near the corners provide access to the wells for the easy filling and aspiration of liquids. This innovative technique supports meniscus-free phase contrast microscopy in a very convenient manner.

Depending on your application, you can choose between the following labware formats:

- [μ-Slide 2 Well<sup>Ph+</sup>](#)
- [μ-Slide 2 Well<sup>Ph+</sup> Glass Bottom](#)
- [μ-Slide 4 Well<sup>Ph+</sup>](#)
- [μ-Slide 4 Well<sup>Ph+</sup> Glass Bottom](#)
- [μ-Dish<sup>35 mm</sup> Quad](#)

## Working with the Ph+ Slides Diminishes the Meniscus Effect

### μ-Slide 2 Well

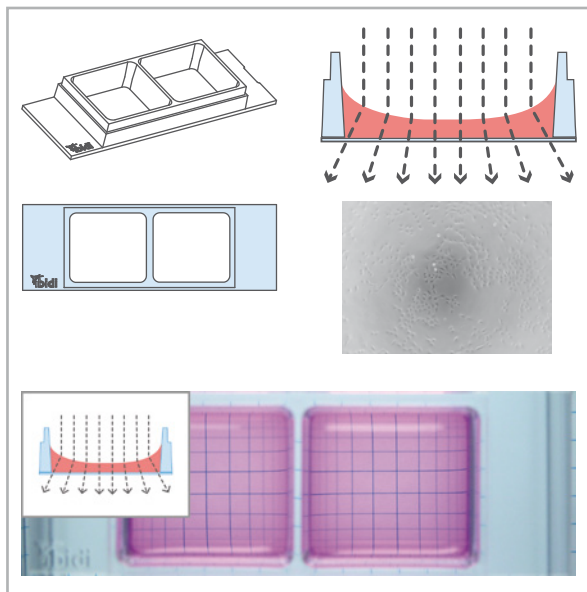

- Poor phase contrast
- Excellent fluorescence microscopy

*Illustration of the perturbing effect of a meniscus. Light is refracted on the air-water-interface, leading to poor contrast in microscopy. Only the small center part exhibits satisfying phase contrast.*

### μ-Slide 2 Well<sup>Ph+</sup>

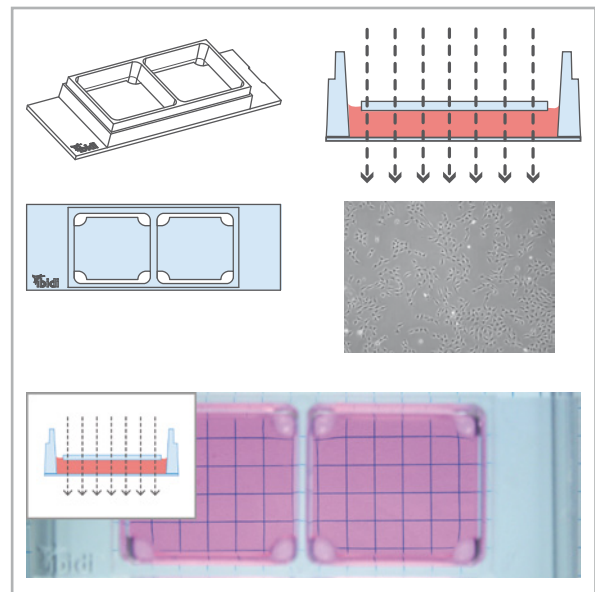

- Excellent phase contrast
- Excellent fluorescence microscopy

*Working with the Ph+ slides diminishes the meniscus and increases the area of well-contrasted cells.*

# Microscopy Parameters of Different Surfaces

## Microscopy Parameters of Different Materials

Material	Thickness	Refractive Index $n_D$ (589 nm)	Auto-fluorescence	Abbe Number
ibidi Polymer Coverslip incl. ibiTreat, Uncoated and Bioinert	#1.5 (180 $\mu\text{m}$ +10/-5 $\mu\text{m}$ )	1.52	Low	56
ibidi Glass Coverslip D 263 M	#1.5H (170 $\mu\text{m}$ +/-5 $\mu\text{m}$ )	1.52	Low	55
Standard glass coverslip	#1.5 (170 $\mu\text{m}$ +20/-10 $\mu\text{m}$ )	1.52	Low	55
Polystyrene (standard Petri Dishes and culture flasks)	Various (typically 1 mm)	1.56	High	53

### Coverslip Thickness

The thickness of the coverslip is a crucial parameter that defines imaging quality. Most of the objective lenses used for microscopy are corrected to the standard coverslip thickness of 0.17 mm (170  $\mu\text{m}$  +20/-10  $\mu\text{m}$ , #1.5). Thinner or thicker coverslips require the use of the correction collar on the objective lens, which then prevents the formation of blurred images by spherical and chromatic aberrations.

The ibidi Polymer Coverslip is the standard bottom of all ibidi  [\$\mu\$ -Slides](#),  [\$\mu\$ -Dishes](#), and  [\$\mu\$ -Plates](#). With a thickness of 180  $\mu\text{m}$  (+10/-5  $\mu\text{m}$ ), the ibidi Polymer Coverslip provides ideal prerequisites for brilliant inverse high-resolution microscopy.

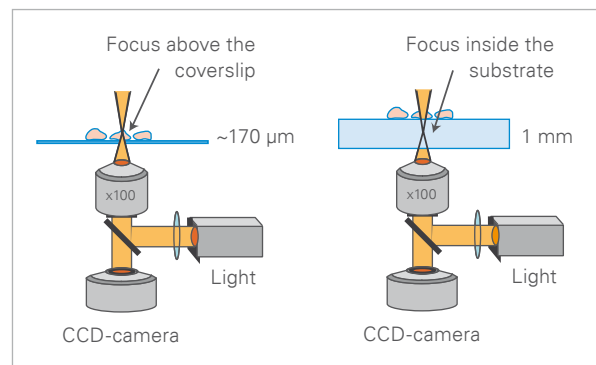

For special microscopy applications, the  [\$\mu\$ -Dishes<sup>35</sup> mm<sub>high</sub>](#), the  [\$\mu\$ -Slide 2 Well | 4 Well | 8 Well](#), and the  [\$\mu\$ -Slide 2 Well<sup>Ph+</sup> | 4 Well<sup>Ph+</sup>](#) are also available with a 170  $\mu\text{m}$  (+/-5  $\mu\text{m}$ ) coverslip glass bottom #1.5H.

### Numerical Aperture

The numerical aperture (NA) is an important value for microscope objectives, which defines their resolution and luminous intensity. It measures the ability of the objective to gather light and resolve fine specimen detail at a fixed object distance. The higher the NA, the greater the ability of an objective is to resolve details of a specimen. The NA is imprinted on every objective.

The numerical aperture is defined by:  $NA = n \sin \theta$ .

$n$  = refractive index of the medium in which the lens works (e.g., 1.52 for immersion oil)

$\theta$  = half-angle of the maximum cone of light that can enter into the lens

For dry objectives, the maximal NA is ~0.95. For immersion objectives, the maximal NA is ~1.4.

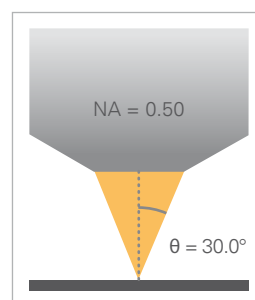

Example of a 20x objective lens with a numerical aperture of 0.5 (20x/0.5).

Find more information about the bottom material compatibilities with different microscopic techniques in the chapter, "[Which Surface for Which Microscopy Technique](#)".

## Refractive Index

The refractive index  $n_D$  measures the speed of light inside a specific material, as compared to the absolute vacuum. It is an important value for calculating the numerical aperture (NA).

The refractive index is defined by:  $n_D = c/\eta$

$c$  = velocity of light in free space

$\eta$  = light velocity in a particular medium

The refractive index is wavelength-dependent. As a standard,  $n_D$  is used to characterize the refractive index of optical materials, which represents 589 nm.

The refractive index is often referred to as “optical density”. Most objectives are designed for use with coverslips that have a standard refractive index of 1.52, including glass and the ibidi Polymer Coverslip.

## Material Dispersion / Abbe Number

Material dispersion is defined as a variation in the refractive index that depends on the wavelength. In other words, dispersion is a measurement for chromatic aberrations.

Dispersion in an optical material is quantified using the Abbe number. It is calculated from the refractive indices of three different wavelengths. Using a material with a high Abbe number means that the refraction index of different wavelengths is nearly

Material	Refractive Index nD
Vacuum	1 (by definition)
Air	1.0003
Water	1.33
Glycerol	1.47
Immersion oil	1.52
Glass coverslip	1.52
ibidi Polymer Coverslip includes ibiTreat, Uncoated and Bioinert	1.52

Immersion oil, which can be seen as an extended front lens of immersion objectives, also has a refractive index of 1.52.

equal in that material, leading to reduced separation of different wavelengths. Therefore, materials with a higher Abbe number give less color dispersion and provide a better optical quality for microscopy.

A material with an Abbe number equal to or larger than 55 is considered to be well-suited for high-resolution microscopy. For example, the ibidi Polymer Coverslip has an Abbe number of 56 and the D 263 M Schott borosilicate glass has an Abbe number of 55.

## Transmission

The transmission of bottom material describes its ability to permit the passage of light through it at specific wavelengths. The more that light is absorbed, the less it can contribute to fluorescence excitation and image acquisition. To be suitable for different microscopy applications, a material should have a high transmission ability across various wavelengths, such as the ibidi Polymer Coverslip.

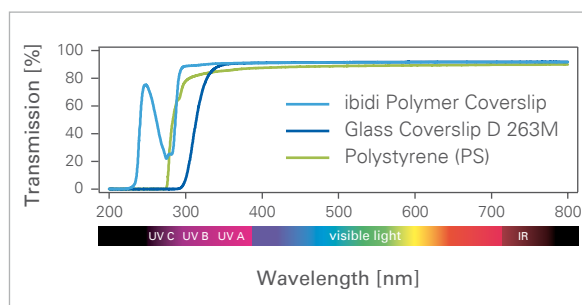

## Autofluorescence

Autofluorescence describes the intrinsic fluorescence intensity of the pure material (e.g., the ibidi Polymer Coverslip or a glass coverslip) without any fluorescent sample. The autofluorescence is emitted by the material and can emerge as noise or background during the imaging process. Autofluorescence can be disruptive, especially when trying to image faint fluorescent signals. All materials and culture media show some degree of autofluorescence, which varies with the excitation/emission wavelength and strongly depends on the material type.

### Autofluorescence Influences the Signal-to-Noise Ratio

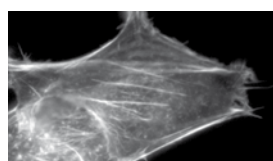

Low autofluorescence using the ibidi Polymer Coverslip.

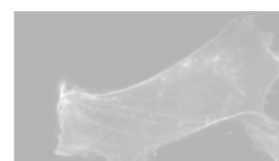

High autofluorescence using a standard culture flask.

## Microscopy Techniques and Culture Surfaces: Find the Perfect Match

### Compatibility of Different Surfaces With Light Microscopy Techniques

	ibidi Polymer Coverslip	ibidi Glass Coverslip	Standard Polystyrene Plates and Dishes
<a href="#">Phase Contrast</a>	++	++	++
<a href="#">Differential Interference Contrast (DIC)</a>	++	++	-
<a href="#">Widefield Fluorescence</a>	++	++	-
<a href="#">Confocal Microscopy</a>	++	++	-
<a href="#">Two-Photon and Multiphoton Microscopy</a>	++	++	-
<a href="#">Fluorescence Recovery After Photobleaching (FRAP)</a>	++	++	-
<a href="#">Förster Resonance Energy Transfer (FRET)</a>	++	++	-
<a href="#">Fluorescence Lifetime Imaging Microscopy (FLIM)</a>	++	++	-
<a href="#">Total Internal Reflection Fluorescence (TIRF)</a>	+	++	-
<a href="#">Super-Resolution Microscopy</a>	+	++	-

## Inverted Microscopy

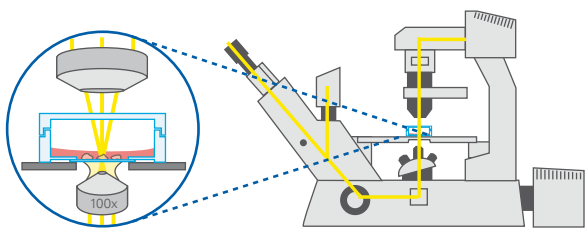

Schematic of an inverted microscope. Note the thin vessel bottom, through which the cells are observed.

### Applications:

Inverted microscopy is a very popular technique for live cell imaging. Here, living cells are observed through the bottom of a cell culture vessel. This technique has several advantages over upright microscopy.

Most cells naturally sink to the bottom of the vessel and—if no suspension cells are used—adhere to the surface, meaning that they are spread across one focal plane. When growing in vessels that are suitable for inverted microscopy, cells have access to larger amounts of medium than if they were squeezed between a coverslip and a slide. In addition, sample access from the top is possible, for medium exchange or micropipettes, for example. Another very important advantage is sterility: as there is no contact between the objective and the sample, sterile working conditions are guaranteed.

### Principle:

In an inverted microscope, the source for transmitted light and the condenser are placed on the top of the stage, pointing down toward the stage. The objectives are located below the stage pointing up. The cells are observed through the bottom of the cell culture vessel. To meet the criteria for successful inverted microscopy, the bottom of the culture vessel must have the highest optical features, which are given for the ibidi Polymer Coverslip and the ibidi Glass Coverslip.

#### ibidi Solutions:

- All ibidi [μ-Slides](#), [μ-Dishes](#), and [μ-Plates](#) are designed for use with different types of inverted microscopes.
- The [ibidi Heating and Gas Incubation System](#) provides a fully functional stage top incubator for establishing *in vivo*-like conditions on every inverted microscope that has a multiwell plate holder or a frame.

## Upright Microscopy

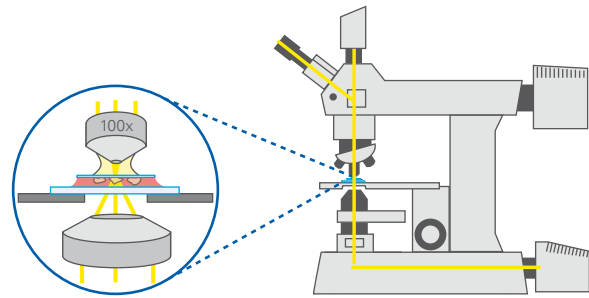

Schematic of an upright microscope. Note that the cells are squeezed between the slide and a coverslip.

### Applications:

In cell biology, upright microscopes are used for phase contrast or widefield fluorescence microscopy of living cells or samples that are squeezed between a slide and coverslip. An additional application is the microscopy of fixed cells or tissue sections.

In principle, upright microscopes can be used for live cell imaging, especially with dipping objective lenses. This type of system is often used for larger samples like tissue and animals.

However, there are several disadvantages of upright microscopes when compared to inverted microscopes. In general, the working distances in upright microscopes are longer, which leads to lower resolution and weaker fluorescence signals. In contrast to inverted microscopes, upright microscopes do not allow for the use of objectives with high numerical aperture directly on the coverslip bottom, on which the cells adhere. Therefore, ibidi recommends inverted microscopes for live cell imaging.

### Principle:

In an upright microscope, the source of transmitted light and the condenser are located below the stage, pointing up. The objectives are placed on top of the stage, pointing down. The specimen is observed from the top through the lid of a petri dish or a coverslip. In some systems, the objective lens is dipped into the culture medium without any coverslip.

#### ibidi Solutions:

- The [3 | 8 | 12 Well Chamber, removable](#) are suitable for use with upright or inverted microscopes.
- The [μ-Slide VI - Flat](#) is compatible with upright or inverted microscopy.
- The [ibidi μ-Dishes<sup>50 mm, low</sup>](#) can be used with upright microscopes when a dipping lens is applied.

# Phase Contrast

## Applications:

Phase contrast is by far the most frequently used method in biological light microscopy. It is an established microscopy technique in cell culture and live cell imaging. When using this inexpensive technique, living cells can be observed in their natural state without previous fixation or labeling.

## Principle:

Unstained living cells absorb practically no light. Poor light absorption results in extremely small differences in the intensity distribution in the image. This makes the cells barely, or not at all, visible in a brightfield microscope. When light passes through cells, small phase shifts occur, which are invisible to the human eye. In a phase contrast microscope, these phase shifts are converted into changes in amplitude, which can be observed as differences in image contrast. However, this label-free technique is strongly dependent on the correct alignment of components in the optical pathway. This alignment can be disturbed by the naturally occurring meniscus effect, causing weak phase contrast.

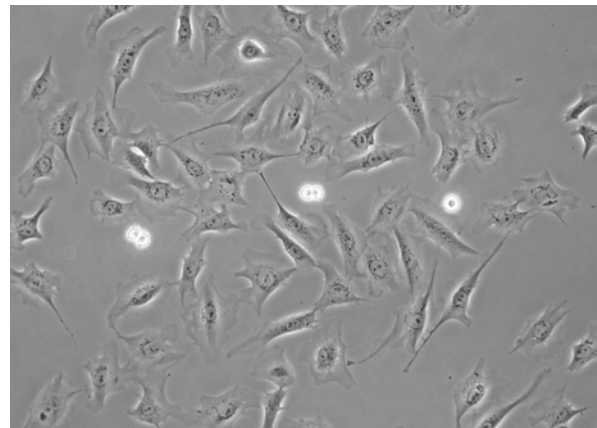

Phase contrast microscopy of Rat1 cells.

F. Zernike. „Phase contrast, a new method for the microscopic observation of transparent objects“. *Physica*, 1942, part I: 10.1016/S0031-8914(42)80035-X, part II: 10.1016/S0031-8914(42)80079-8.

E. Horn, R Zantl. *Phase-Contrast Light Microscopy of Living Cells Cultured in Small Volumes. Microsc Anal*, 2006, 20(3):5–7

## ibidi Solutions:

An important issue to be considered in phase contrast microscopy is the meniscus, which is naturally formed at the air-liquid interface. This phenomenon can significantly reduce the image quality, especially in small culture wells like the standard 96 well plates. The diffraction, due to the meniscus, disarranges the correct alignment of the phase ring and phase plate inside the optical pathway.

ibidi has developed several solutions to overcome this problem—and guarantee excellent phase contrast images:

- [μ-Slide Angiogenesis](#) and [μ-Plate Angiogenesis](#)
- [Channel μ-Slides](#)
- [μ-Slides Ph+](#)

For detailed information, please refer to “[Phase Contrast in Channel Slides](#)” or read our [Application Note 03 \(PDF\)](#).

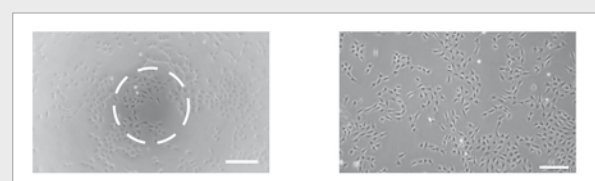
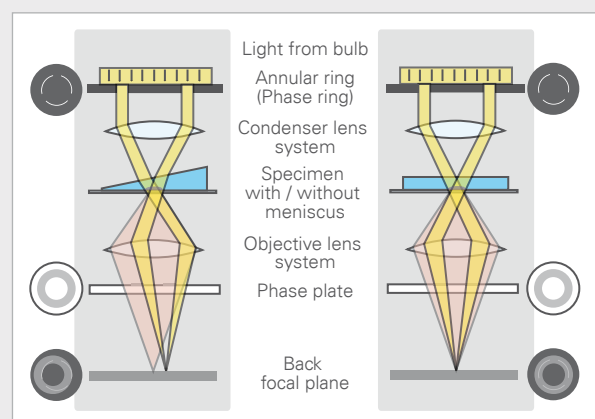

**Beam path with meniscus**  
No alignment, bad phase contrast.

**Beam path without meniscus**  
Correct alignment, good phase contrast.

## ibidi $\mu$ -Slide Angiogenesis and $\mu$ -Plate Angiogenesis

The [ibidi  \$\mu\$ -Slide Angiogenesis](#) and [ibidi  \$\mu\$ -Plate Angiogenesis 96 Well](#) are not only designed for angiogenesis and tube formation assays, they also provide the ideal cell culture vessel for brilliant phase contrast images. A geometrical trick, the „well in a well“ technology, inhibits the meniscus formation and results in good phase contrast over the entire observation area.

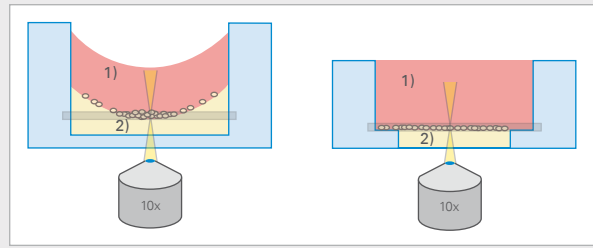

### Standard well

- 1) Meniscus on air-liquid interface: poor phase contrast in most of the observation area.
- 2) Meniscus on the gel surface: not possible to focus on all cells simultaneously.

### $\mu$ -Slide / Plate Angiogenesis

- 1) Planar air-liquid interface: good phase contrast all over the observation area.
- 2) Planar gel surface: all cells are in one optical plane.

## ibidi Channel $\mu$ -Slides

The ibidi [channel  \$\mu\$ -Slides](#) provide ideal optical conditions for phase contrast microscopy. When culturing cells, the channel is filled with medium from bottom to top. This geometrically inhibits meniscus formation and allows for excellent phase contrast across the whole channel.

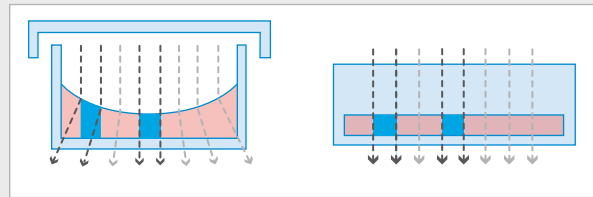

### 96 well plate / small open well

Strong meniscus, low contrast near the edges.

### Channel or parallel plates

No meniscus, good phase contrast over the entire area.

## ibidi $\mu$ -Slides Ph+

The ibidi [ibidi  \$\mu\$ -Slides Ph+](#) are specifically designed for phase contrast microscopy. A special intermediate plate in each well avoids meniscus formation and guarantees brilliant phase contrast—no matter which part of the well is being imaged.

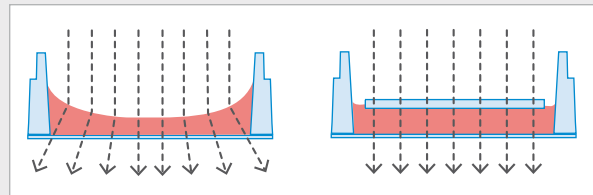

### Standard well

Strong meniscus effect.

### Ph+ well

No meniscus effect.

# Differential Interference Contrast (DIC)

## Applications:

DIC is a more expensive, label-free microscopy technique with a high sensitivity to thin cellular material, even when it is located within thick tissue. It is useful for rendering contrast in transparent samples and gives brilliant pseudo-3D relief shading images. Although DIC images look very appealing, the pseudo-3D effect might be misleading in some cases, making it seem that the cells have structures that they do not have. As an example, areas inside a living cell with a different refractive index, like vacuoles and chromatin, appear as bumps, which is actually an optical impression.

## Principle:

Similar to phase contrast, DIC microscopy is a contrast-enhancing technique. DIC uses polarized light to convert phase delays into intensity changes (contrast). The effect is called differential, because contrast is created only in neighboring areas. Unlike in phase contrast, the DIC image is not built globally over the entire image. Instead, adjacent structures with different refractive indices are contrasted when in close contact with each other.

DIC is less sensitive to meniscus formation than phase contrast. However, DIC needs low birefringence of the microscopy chamber and the lid, making it incompatible with standard polystyrene cultureware. Since many factors can influence the recovery kinetics, the FRAP experiments have to be planned well and the resulting data must be analyzed carefully. It is then possible to obtain the diffusion coefficient and molecule mobility parameters using mathematical modelling.

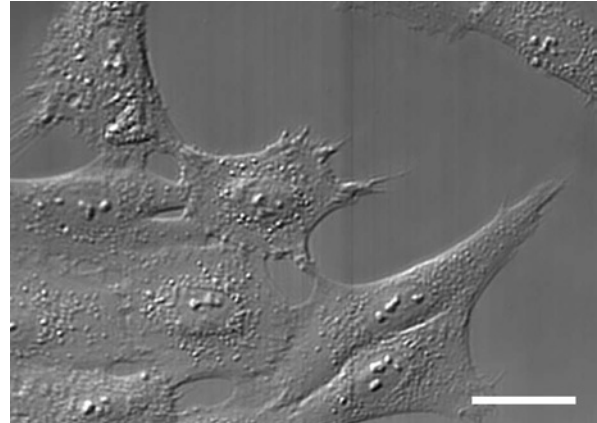

DIC microscopy of Rat1 cells. Scale bar 20  $\mu\text{m}$ .

## ibidi Solutions:

- Unlike other polymers on the market, the ibidi Polymer Coverslip is DIC compatible.
- Glass coverslip bottoms are 100% compatible with DIC microscopy.
- ibidi offers a special [DIC Lid for  \$\mu\$ -Dishes](#) and a [DIC Lid for  \$\mu\$ -Slides](#).  
*Please note: Regular plastic lids are not suitable for DIC due to their high birefringence.*
- *Please note: Due to their injection-molded top, the ibidi channel slides are not compatible with DIC.*



## Widefield Fluorescence Microscopy

### Applications:

Fluorescence microscopy is applied for the detection of specific structures, molecules, or proteins within a cell. When using this technique, almost any component of living and fixed cells or tissues can be “stained” and thereby specifically imaged—up to the highest magnifications. Immunofluorescence assays are widely analyzed using widefield fluorescence microscopy. It is also possible to visualize several structures in parallel, which then appear as different pseudocolors in the obtained image.

### Principle:

Widefield fluorescence microscopy is a variation of light microscopy and the easiest fluorescence imaging mode. The underlying key principle is the use of fluorescent molecules—so-called fluorophores—for the labeling of defined cellular structures. These molecules, such as green fluorescent protein (GFP), absorb light at a specific wavelength (excitation) and emit it at a specific higher wavelength (emission). To visualize the molecule of interest, fluorophore-coupled specific antibodies or proteins, for example, are transferred into the cell. The specimen is then illuminated at the excitation wavelength and viewed through a filter that allows only the emitted wavelength to pass through. Whereas the background is dark, the structures with a bound fluorophore emit light, indicating the presence of the structure of interest.

In contrast to confocal microscopy, the whole specimen is exposed to light in widefield fluorescence microscopy. Fluorescence signals from all focal planes are detected, which leads to lower contrast in thick samples like spheroids and tissue. Therefore, widefield microscopy is best applied with thin specimens with low background autofluorescence, like adherent cells.

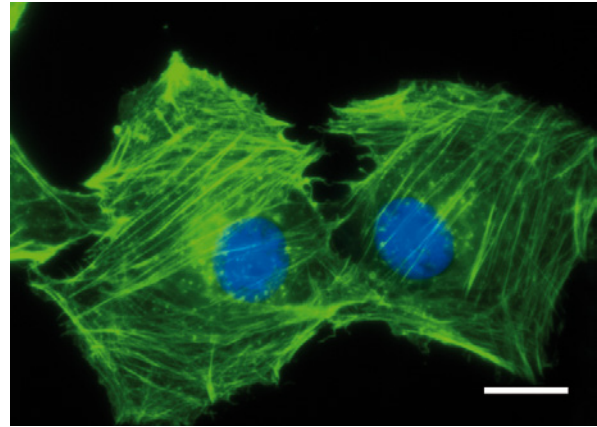

Fibroblasts were cultivated on the ibidi Polymer Coverslip for 24 hours following paraformaldehyde fixation. F-actin and nuclear DNA were stained with Phalloidin (green) and DAPI (blue), respectively, before mounting with ibidi Mounting Medium. Widefield fluorescence microscopy, Carl Zeiss Axiovert 100, objective lens Plan-Neofluar 100x/1.3 oil, scale bar 10  $\mu$ m.

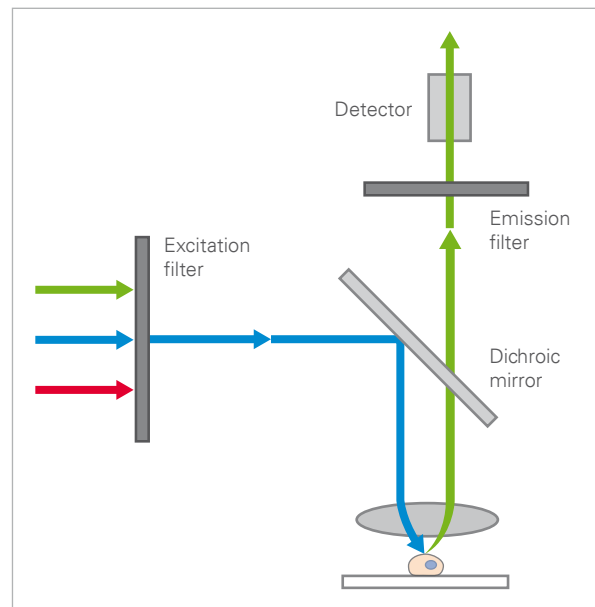

Light pathways in a widefield microscope.

### ibidi Solutions:

- The ibidi Polymer Coverslip and the ibidi Glass Coverslip provide ideal optical conditions for fluorescence microscopy. Widefield fluorescence is possible without restrictions when using any of the ibidi labware that contains the ibidi Polymer Coverslip or the ibidi Glass Coverslip bottom.
- The [LifeAct](#) product line uses fluorescent proteins, such as GFP2 and RFP, to visualize F-actin in living cells with unrestricted functionality.
- [Fuse-It-Color](#) enables easy and rapid labeling of cell membranes. It is available with four different emission spectra.

# Confocal Microscopy

## Applications:

Confocal microscopy is broadly used to resolve the detailed structure of specific objects within the cell. Similar to widefield fluorescence microscopy, various components of living and fixed cells or tissue sections can be specifically labeled using immunofluorescence, for example, and then visualized in high resolution.

As a distinctive feature, confocal microscopy enables the creation of sharp images of the exact plane of focus, without any disturbing fluorescent light from the background or other regions of the specimen. Therefore, structures within thicker objects can be conveniently visualized using confocal microscopy. Furthermore, by stacking several images from different optical planes, 3D structures can be analyzed. The sample penetration depth is limited, however, when using confocal microscopy. Thicker objects, like large spheroids, organoids, tissue, and small animals, should instead be optimally imaged using two-photon microscopy or LSM.

## Principle:

Similar to the widefield microscope, the confocal microscope uses fluorescence optics. Instead of illuminating the whole sample at once, laser light is focused onto a defined spot at a specific depth within the sample. This leads to the emission of fluorescent light at exactly this point. A pinhole inside the optical pathway cuts off signals that are out of focus, thus allowing only the fluorescence signals from the illuminated spot to enter the light detector.

By scanning the specimen in a raster pattern, images of one single optical plane are created. 3D objects can be visualized by scanning several optical planes and stacking them using a suitable microscopy deconvolution software (z-stack). It is also possible to analyze multicolor immunofluorescence stainings using state-of-the-art confocal microscopes that include several lasers and emission/excitation filters.

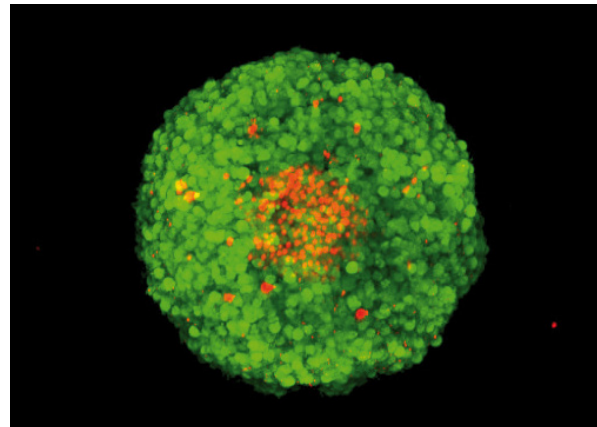

Z-stack of an FDA/PI-stained MCF-7 spheroid, acquisition by confocal microscopy. Green: FDA-stained living cells. Red: PI-stained dead cells in the necrotic center of the spheroid.

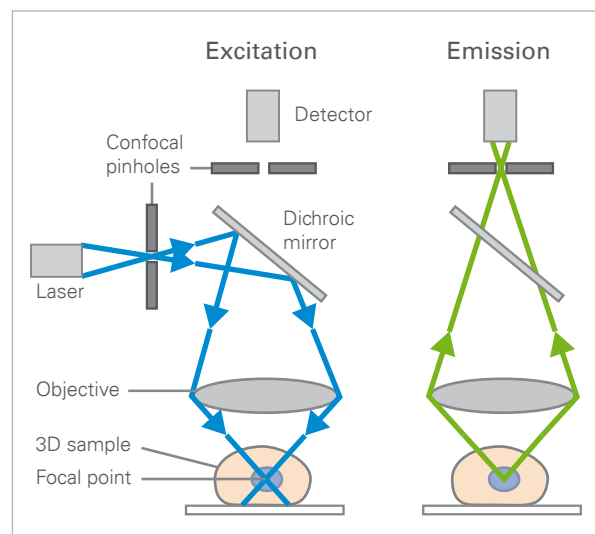

Excitation and emission light pathways in a basic confocal microscope configuration.

## ibidi Solutions:

- The ibidi Polymer Coverslip and the ibidi Glass Coverslip provide ideal optical conditions for fluorescence microscopy. Confocal microscopy is possible without restrictions when using any of the ibidi labware that contains the ibidi Polymer Coverslip or the ibidi Glass Coverslip bottom.
- The [LifeAct](#) product line uses fluorophores to visualize F-actin in living cells with unrestricted functionality.
- [Fuse-It-Color](#) enables easy and rapid labeling of cell membranes. It is available with four different emission spectra.

## Two-Photon and Multiphoton Microscopy

### Applications:

Two-photon microscopy (also called multiphoton microscopy) can be used for live cell imaging of thick biological specimens, as it has several advantages over confocal microscopy. Molecules can be visualized deeply within the specimen with a maximal penetration depth of about 1 mm. This enables 3D imaging of tissue slices, organoids, whole organs, embryos, or even whole animals.

In contrast to confocal microscopy, two-photon microscopy works with higher wavelengths leading to less photobleaching or photodamage, which is especially important when working with living samples.

### Principle:

Just like widefield or confocal fluorescence microscopy, two-photon microscopy is based on fluorophore excitation, which results in the emission of light. In classic fluorescence microscopy, a fluorophore is excited by absorbing one single photon of a certain wavelength. When using two-photon microscopy, two or three photons of a higher wavelength do the work of one: When they hit the fluorophore at the very same time (typically within several femtoseconds), they are absorbed, resulting in fluorophore excitation and emission of light.

In this process, photons combine their energy, which allows low-energy infrared photons to excite standard fluorophores, such as GFP. The infrared light penetrates tissue more deeply than the standard excitation light used in fluorescence microscopy. Due to its low energy level, infrared light is less damaging, and therefore especially useful when working with living samples.

In order to increase the likelihood that two photons hit the fluorophore simultaneously, lasers with very high intensity are needed. Their infrared light only leads to excitation in the focus of the objective, because only in this area, the critical number of photons per time and space is reached. Therefore, all emitted light comes from one focal point in the specimen, strongly reducing background noise. The image is created just as in confocal microscopy: The laser scans across the sample, recording the image intensity point by point..

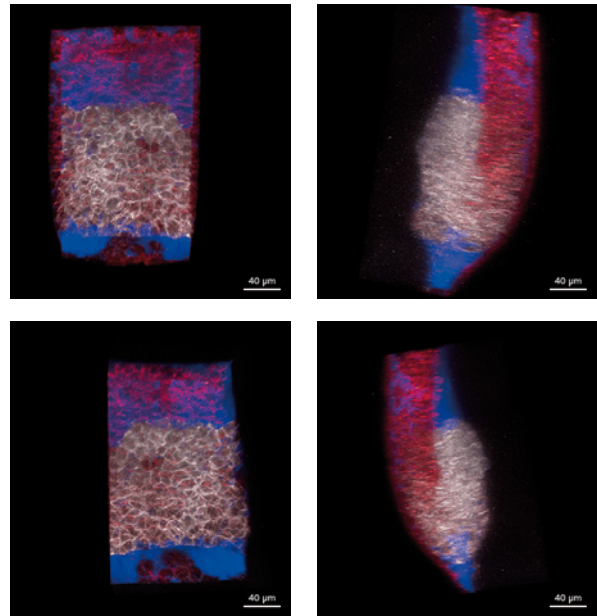

Rotating 3D rendering of a confocal image stack showing the dorsal germ ring of a zebrafish embryo at the onset of gastrulation (6 hours post fertilization). GFP (white) is expressed in internalizing prechordal plate progenitors and lyn-TagBFP (red) marks the membrane in all cells. The embryo was injected with dextran-rhodamine to label the interstitial fluid (blue). The image was recorded at the Bioimaging Facility of the Institute of Science and Technology Austria (IST), using a multiphoton LaVision BioTec TriM Scope microscope.

R.K.P. Benninger, D.W. Piston. Two-photon excitation microscopy for the study of living cells and tissues. *Curr Protoc Cell Biol*, 2013, 10.1002/0471143030.cb0411s59

### ibidi Solutions:

- The ibidi Polymer Coverslip and the ibidi Glass Coverslip provide ideal optical conditions for fluorescence microscopy. Two-photon microscopy is possible without restrictions when using any of the ibidi labware that contains the ibidi Polymer Coverslip or the ibidi Glass Coverslip bottom.
- The [LifeAct](#) product line uses fluorophores to visualize F-actin in living cells with unrestricted functionality.

## Fluorescence Recovery After Photobleaching (FRAP)

### Applications:

FRAP is a fluorescence microscopy method for studying the mobility of fluorescently-labeled molecules in living cells. It is applied for the analysis of molecule diffusion within the cell, fluidity of bio membranes, and protein binding.

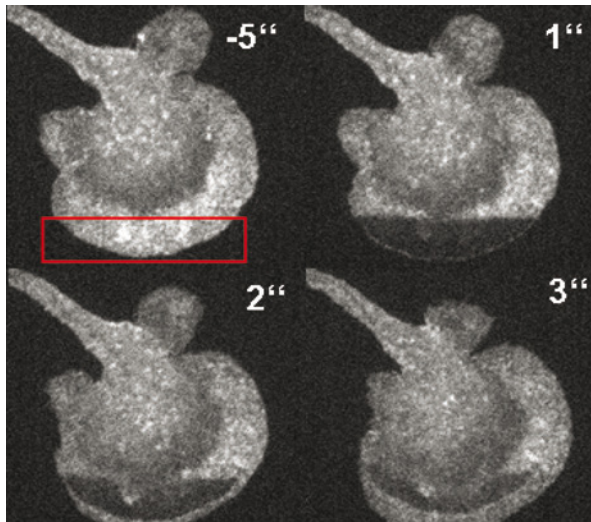

FRAP-based visualization of the F-actin diffusion in a primary dendritic cell using LifeAct.

### Principle:

FRAP can be conducted using a modern confocal microscope. It needs fluorescent labeling of the molecule of interest. A typical FRAP experiment involves three distinct phases. First, the initial fluorescence is measured in the region of interest. Next, the fluorescent molecules are photobleached within a selected area. This is done by focusing the laser beam onto the respective area, leading to intense illumination and extinction of the fluorophores. As a result, a dark area in the otherwise fluorescent sample can be observed. Finally, fluorescent molecules from the surroundings can diffuse through the sample and exchange the photobleached molecules with intact ones. This fluorescence recovery is measured over time, making it possible to obtain the diffusion coefficient and molecule mobility parameters.

### ibidi Solutions:

The ibidi Polymer Coverslip and the ibidi Glass Coverslip provide ideal optical conditions for fluorescence microscopy. FRAP and LSM are possible without restrictions when using any of the ibidi labware that contains the ibidi Polymer Coverslip or the ibidi Glass Coverslip bottom.

*Please note: The suitability of the ibidi labware for LSM depends on the well/channel geometry, the used LSM system and its optical setup. It has to be checked individually before each experiment.*

## Light Sheet Fluorescence Microscopy (LSFM)

### Applications:

LSFM is applied for live cell 3D imaging of thick biological samples as a whole, such as embryos, spheroids, organoids, and whole animals. The strongly reduced background signal, minimized phototoxicity, and increased scanning speed make LSM superior to epifluorescent microscopy for the analysis of thick living specimens.

### Principle:

Researchers can choose between several LSM/SPIM (Single/Selective Plane Illumination Microscopy) systems that differ in certain aspects but all have the following main features: in contrast to confocal or widefield fluorescent microscopy only a thin section of the specimen is illuminated by a light sheet. Another important difference is the separation of the optical pathways of illumination and detection. To avoid the measurement of out-of-focus fluorescence, emitted light is detected on a different axis to the illumination (e.g., orthogonal). By doing this, unnecessary out-of-focus fluorescence is not excited, which prevents photobleaching and photodamage in regions that are currently not being scanned. Finally, with LSM, the image is created by scanning a plane of light (optical sectioning), instead of point by point, which markedly increases scanning speed when compared to confocal microscopy.

These advantages—reduced cellular stress, background fluorescence, and time consumption—are especially important when doing 3D live cell imaging of sensitive biological samples.

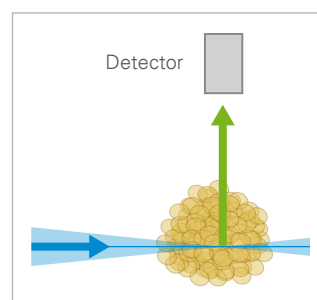

The principle setup of LSM.

## Förster Resonance Energy Transfer (FRET)

### Applications:

FRET determines the precise location and spatial proximity of fluorescently labeled molecules and their interactions in living cells. Using this technique, protein-protein interactions or conformation changes, for example, can be analyzed using a standard widefield or confocal fluorescence microscope. Using specific calcium-sensitive biosensors, FRET can also be applied for the visualization of changes in cellular calcium concentration.

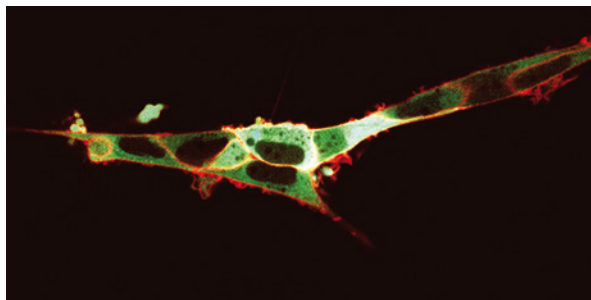

*FRET-based visualization of cytoplasmic calcium concentration. HEK293 cells expressing NK-1 on the outer cell membrane and the calcium biosensor Yellow Cameleon 3.6 (YC3.6) in the cytoplasm. Addition of the fluorescently labelled NK-1 ligand (SP-TAMRA) results in a red glow of the cell membrane. Upon receptor activation, calcium release induces a change in the YC3.6 fluorescence properties: CFP excitation yields simultaneous CFP and YFP emissions by a FRET phenomenon, appearing as a green glow in the cytoplasm. Provided by M. Roelse, Wageningen, The Netherlands.*

### Principle:

A donor fluorophore in its excited state can transfer its excitation energy to an acceptor fluorophore in a non-radiative fashion. Typically, this happens through dipole-dipole coupling in a distance of less than 10 nm. Beyond that distance (Förster radius), the two fluorophores show normal fluorescence behavior.

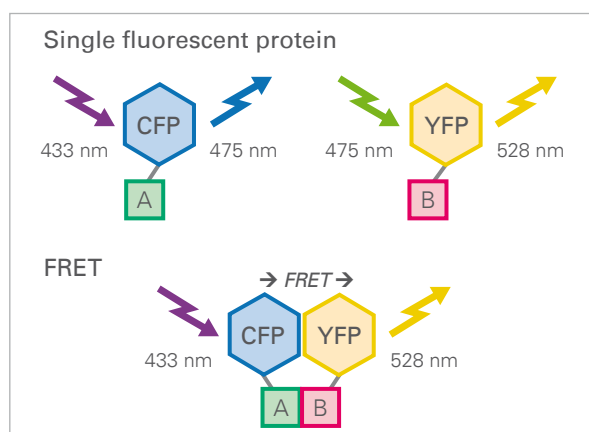

*FRET protein interaction assay. A membrane receptor A and its ligand B are tagged with CFP and YFP, respectively. When the ligand binds to the receptor, the YFP is excited by FRET.*

## Fluorescence Lifetime Imaging Microscopy (FLIM)

### Applications:

FLIM is used for analyzing the distribution of specific cellular components, such as proteins or nucleic acids. It can be used to gain information about the molecules and to visualize the state of the environment that surrounds the respective molecule in living cells. FLIM helps to measure several factors, such as calcium ion amount, pH, oxygen concentration, molecular interaction, and molecular binding. Under optimal conditions, it is even possible to detect and identify single molecules. The penetration depth using FLIM is higher compared to standard fluorescence microscopy, which enables the analysis of thicker samples.

### Principle:

In contrast to standard fluorescence microscopy where the intensity is used to create an image of the specimen, FLIM uses the lifetime of the signal by analyzing the fluorophore's exponential decay rate. The fluorescence lifetime is specified as the average time that a fluorophore stays in the excited state before emitting a photon and returning to the ground state. In the excited state, each type of fluorophore has its own lifetime. By detecting differences in lifetime, it is possible to distinguish fluorophores that have the same excitation and emission spectrum.

The fluorescence lifetime depends on the local environment. While it is affected by factors such as molecular interaction or ion concentration, it is not influenced by fluorophore concentration, photobleaching, or excitation light intensity. The resulting FLIM image contrasts the lifetime of the individual fluorophores, which can then be used to define and interpret the environmental factors of the molecules of interest. The lifetime also changes when an energy acceptor molecule is in close proximity. This combination of FLIM and FRET gives detailed insight into sub-molecular binding processes.

*H.C. Ishikawa-Ankerhold, R. Ankerhold, G.P.C. Drummen. Advanced Fluorescence Microscopy Techniques—FRAP, FLIP, FLAP, FRET and FLIM. Molecules, 2012, 10.3390/molecules17044047*

### ibidi Solutions:

The ibidi Polymer Coverslip and the ibidi Glass Coverslip provide ideal optical conditions for fluorescence microscopy. FRET and FLIM microscopy are possible without restrictions when using any of the ibidi labware that contains the ibidi Polymer Coverslip or the ibidi Glass Coverslip bottom.

# Total Internal Reflection Fluorescence (TIRF)

## Applications:

TIRF is a fluorescence-based technique used to image the processes that occur in and near the membrane of living cells. Although TIRF cannot be used to visualize structures located deep within a specimen, it allows for near-membrane imaging close to the interface with a high signal-to-noise ratio. TIRF is very useful visualizing membrane processes, such as receptor-ligand interactions, endocytosis, viral infection, or cell adhesion to surfaces.

## Principle:

For TIRF, two optical media with different refractive indices, such as water ( $n_D=1.33$ ) and glass ( $n_D=1.52$ ), are needed. If the total internal reflection of incident light occurs at the interface of these media, an evanescent field is created. This evanescent field is an area in which the totally reflected light is still able to excite fluorophores. It extends about 100–200 nm deep into the specimen, leading to the excitation of fluorophores. Only the fluorescent events occurring at the section of the specimen close to the glass/sample interface are then visualized.

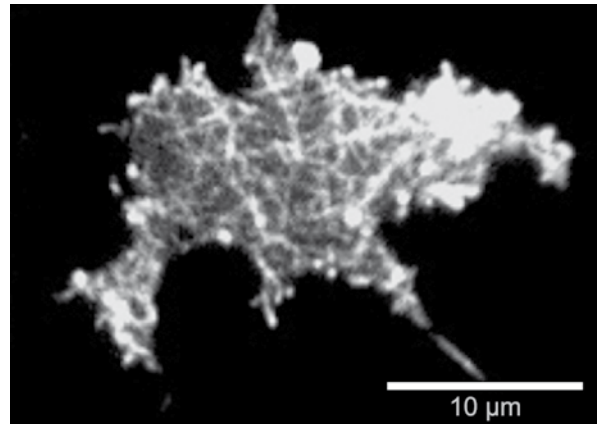

Surface-near F-actin network of a *Dictyostelium discoideum* DdLimE-GFP cell. TIRF Live cell imaging on a Glass Coverslip #1.5H.

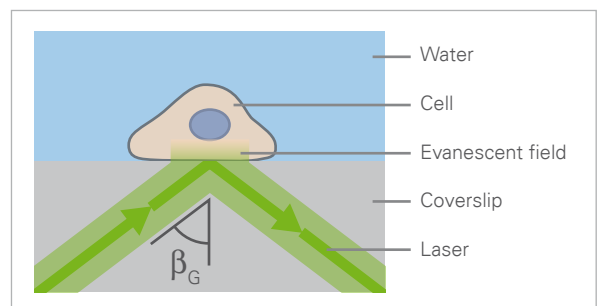

The principle of TIRF microscopy.

## ibidi Solutions:

- The ibidi Glass Coverslip bottom provides ideal optical conditions for TIRF. It is possible to use any of the ibidi labware, without restrictions, containing the ibidi Glass Coverslip bottom.

*Please note: TIRF is generally possible with the ibidi Polymer Coverslip, but we recommend using the ibidi Glass Coverslip.*

- The [LifeAct](#) product line uses fluorophores to visualize F-actin in living cells with unrestricted functionality.
- [Fuse-It-Color](#) enables easy and rapid labeling of cell membranes. It is available with four different emission spectra.

# Super-Resolution Microscopy (STED, SIM, (F)PALM, (d)STORM)

## Applications:

Super-resolution microscopy enables the visualization of the smallest structures in living cells that cannot be resolved using standard widefield or confocal fluorescence microscopy. This technique provides a spatial 3D-resolution that is well below the diffraction limit. It creates new views on the structural organization of cells and the dynamics of biomolecular assemblies, that are close to a near-molecular resolution.

## Principle:

Resolution is described as a function to discriminate two dots from each other. It is dependent on the wavelength and the numerical aperture and is physically limited by Abbe's law.

When using widefield and confocal fluorescence microscopy, the diffraction barrier limits the maximal resolution to about 200 nm. Super-resolution microscopy breaks the diffraction barrier, enabling "nanoscopy" with substantially improved optical resolution of down to 5–20nm. This method uses the physical or chemical properties of adjacent fluorophores to resolve them from each other. For example, while one fluorophore's state is "on", the neighboring fluorophore's state is "off", which enables their differentiation.

Several super-resolution microscopy techniques were developed, each with its own advantages and disadvantages. There are deterministic and stochastic functional techniques. Common examples are:

- Stimulated emission depletion (STED)
- Saturated structured illumination microscopy (SSIM)
- REversible Saturable Optical Linear Fluorescence Transitions (RESOLFT)
- Photoactivated localization microscopy (PALM)
- Fluorescence photoactivation localization microscopy (FPALM)
- Stochastic optical reconstruction microscopy (d)STORM

*S.W. Hell. Far-field optical nanoscopy. Science, 2007, 10.1126/science.1137395*

*S.W. Hell. Microscopy and its focal switch. Nat Methods, 2009, 10.1038/nmeth.1291*

*B. Huang, H. Babcock, X. Zhuang. Breaking the diffraction barrier: super-resolution imaging of cells. Cell, 2010, 10.1016/j.cell.2010.12.002*

*S.J. Sahl, S.W. Hell, S. Jakobs. Fluorescence nanoscopy in cell biology. Nat Rev Mol Cell Biol, 2017, 10.1038/nrm.2017.71*

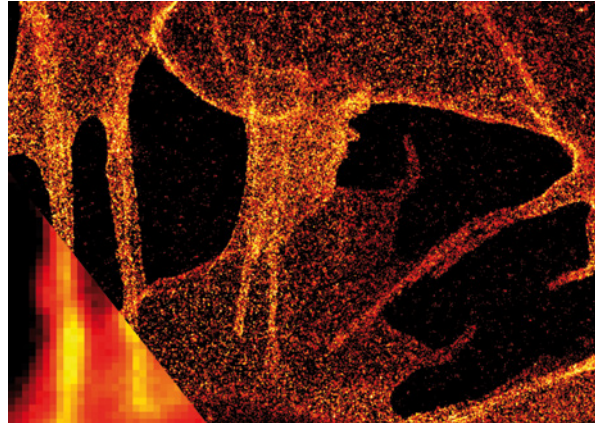

*dSTORM image of plasma membrane glycans on the ibidi Polymer Coverslip. Membrane glycans of SK-N-MC neuroblastoma cells were stained through the metabolic incorporation of azido-sugar analogues followed by copper-catalyzed azide-alkyne cycloaddition (CuAAC). Inlet: comparison to widefield microscopy. Provided by Markus Sauer, Würzburg.*

## ibidi Solutions:

In general, we can recommend the ibidi Glass Coverslip bottom for super-resolution microscopy techniques. The ibidi Polymer Coverslip, however, cannot yet be guaranteed to work with every microscopic technique due to the large number of techniques available.

*Please note: dSTORM is possible with the ibidi Polymer Coverslip.*

If you would like to take advantage of the ibidi Polymer Coverslip bottom features and test them with your own super-resolution microscopy experiments, please check out our [free sample!](#) Then, give us feedback on how the ibidi Polymer Coverslip worked with your technique of choice.

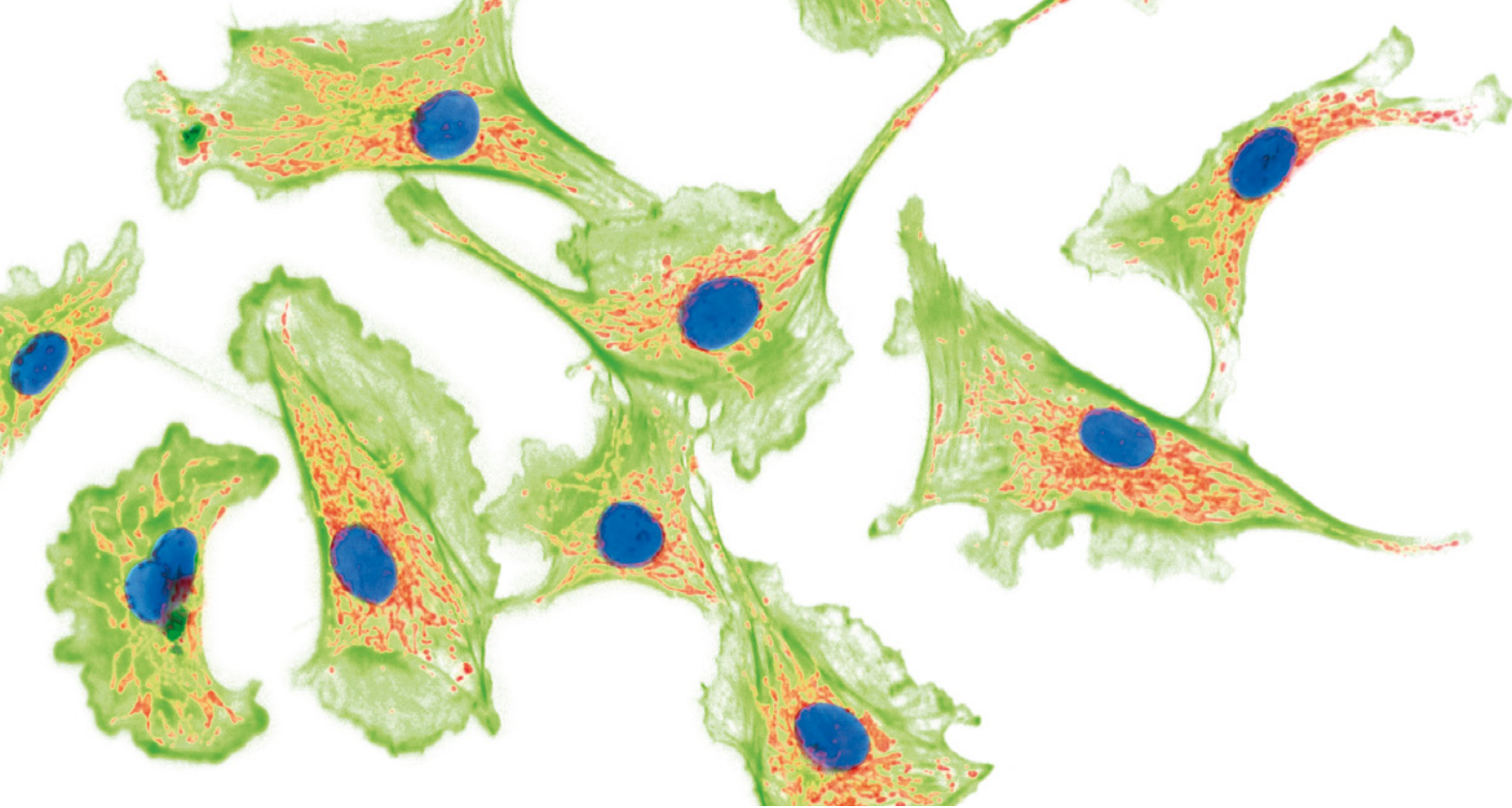

#### **Manufacturer**

**ibidi GmbH**  
Lochhamer Schlag 11  
82166 Gräfelfing  
Germany

**Toll free within Germany:**  
Phone: 0800/00 11 11 28  
Fax: 0800/00 11 11 29

**International calls:**  
Phone: +49 89/520 46 17-0  
Fax: +49 89/520 46 17-59

**E-Mail:** [info@ibidi.com](mailto:info@ibidi.com)  
[ibidi.com](http://ibidi.com)

#### **North American Headquarters**

**ibidi USA, Inc.**  
2920 Marketplace Drive  
Fitchburg, WI 53719  
USA

**Toll free within the US:**  
Phone: +1 844 276 6363

**International calls:**  
Phone: +1 608 441 8181  
Fax: +1 608 441 8383

**E-Mail:** [ibidiusa@ibidi.com](mailto:ibidiusa@ibidi.com)  
[ibidi.com](http://ibidi.com)

*All ibidi products are for research use only! Errors and omissions excepted.*

© ibidi GmbH  
FL\_AG\_031, V 1.2 2019/06

For free samples, application notes, and handling movies,  
please visit us at:

 **ibidi.com**