

2D and 3D Chemotaxis Assays Using μ -Slide Chemotaxis



0 Important Notes

- Read the related document first: “Important Handling Information for the μ -Slide Chemotaxis – READ THIS BEFORE USE”.
- Follow all of the steps in this Application Note carefully.
- Start by using the free samples and the food coloring, which are included.
- Read through the detailed information in the “Notes” section, at the end of this document.

Table of Contents

0	Important Notes	1	10.1	Data Analysis	13
1	General Information	2	10.2	Criteria for a Chemotaxis Effect.....	13
2	Principle	2	10.3	Presenting Results.....	14
2.1	3D Chemotaxis Experiments in Gel Matrices	3	11	Tips, Tricks, and Troubleshooting	15
2.2	2D Chemotaxis Experiments Without Gel	3	11.1	Avoiding Air Bubbles.....	15
3	Equipment.....	4	11.2	Focus Not Stable	16
4	Surfaces and Coatings	4	11.3	Chamber Not Filling Properly	16
4.1	ibiTreat (80326).....	4	11.4	Cells Die in the Gel Matrix	16
4.2	Collagen IV Coated Surface (80322).....	4	11.5	Cells Do Not Migrate in Gel	17
5	3D Experiment with Cells in Gel	5	11.6	Matrix not Homogeneous, Inconsistent Gel or Fibers with Preferred Direction ...	17
5.1	Seeding Cells in a Gel Matrix	5	11.7	Cells Do Not Attach Properly (2D Assay Only)	17
5.2	Filling the Reservoirs	6	11.8	Inhomogeneous Cell Distribution (2D Assay Only)	18
6	2D Experiment with Cells on a 2D Surface	7	11.9	Low reproducibility of results	18
6.1	Seeding Cells.....	7	12	Notes.....	18
6.2	Cell Attachment.....	8	12.1	Note: Gel Filling	18
6.3	Filling the Reservoirs	9	12.2	Note: Cell Morphology	18
7	Video Microscopy.....	10	12.3	Note: Cell Tracking	19
8	Chemoattractant Concentrations and Recommended Experimental Setups	11	12.4	Note: Chemoattractant filling with “Fast Method”	19
9	Tracking Cells as a 2D Projection.....	11	12.5	Note: Optimizing Experimental Time	19
10	Analyzing Chemotaxis	13			

1 General Information

The μ -Slide Chemotaxis is a tool used for observing the chemotactical response of cells exposed to chemical gradients. It works for adherent cells on a 2D surface as well as for cells being embedded in a 3D gel matrix.

Color code for liquids in this Application Note:

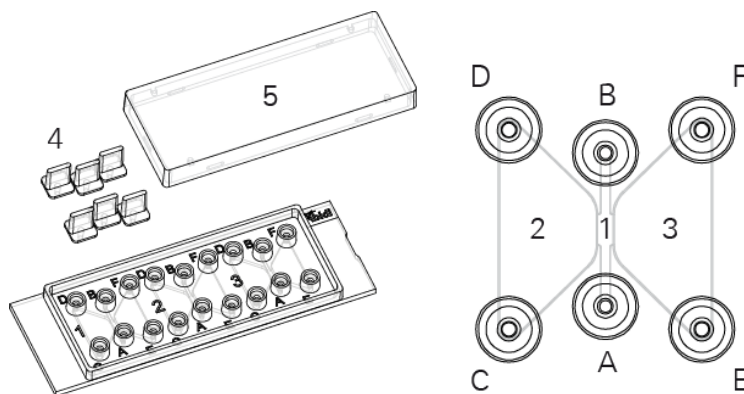
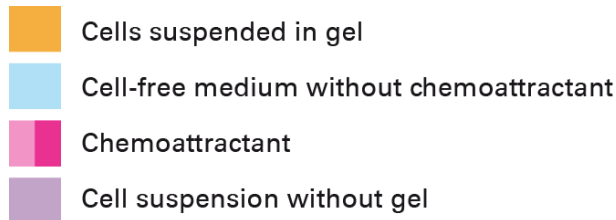

Chamber configuration:

- 1) Observation area (1000x2000 μm^2)
 - 2) Left reservoir (60 μl)
 - 3) Right reservoir (60 μl)
 - 4) Plugs
 - 5) Cultivation lid
- A) Filling Port A (with side channel)
 B) Filling Port B (with side channel)
 C) Filling Port C (left side)
 D) Filling Port D (left side)
 E) Filling Port E (right side)
 F) Filling Port F (right side)

2 Principle

Two large-volume reservoirs (2 and 3) are connected by a small gap (1). A linear concentration gradient forms inside this gap if those large reservoirs contain different chemoattractant concentrations (indicated in this document by the red and blue colors). Cells that are placed into this gap (=observation area) are exposed to this linear concentration gradient. In steady state, there is a homogeneous concentration inside the large reservoirs.

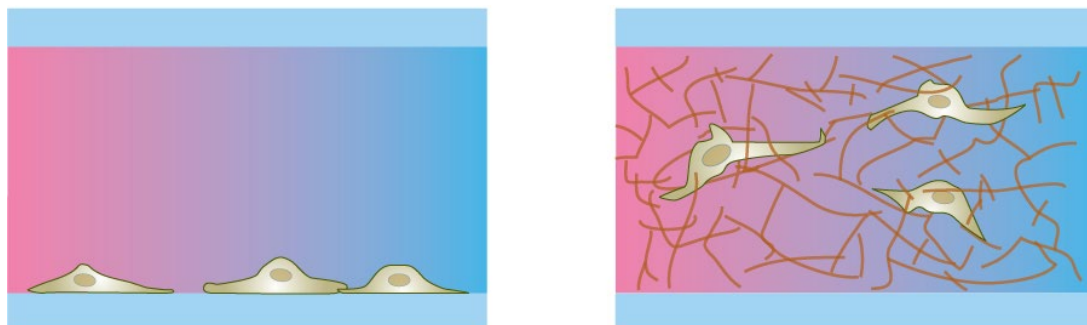

Cross section of the observation area with adherent cells (left) and cells in a gel (right).

2.1 3D Chemotaxis Experiments in Gel Matrices

When conducting 3D experiments, the observation area is filled with cells that are surrounded by a gel. This gel hinders the convective flow of liquid, so that both large reservoirs can be filled either with neutral medium or with chemoattractant, respectively. This 3D chemotaxis experiment is described in detail in Section 5 (page 5).

Typical aqueous gels (like collagen gels) are not thought to hinder diffusion. This approach is invalid when using stiff hydrogels with pore sizes in the range of the diffusing molecule as no chemical gradient can be established using these.

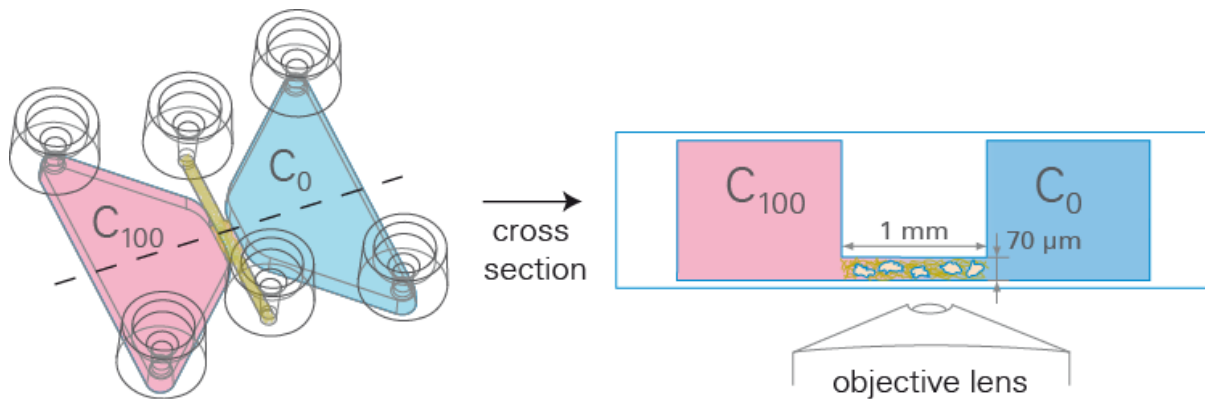

2.2 2D Chemotaxis Experiments Without Gel

It is also possible to conduct 2D experiments without the use of a gel. For this application, cells need to be attached to the surface of the observation area. This 2D chemotaxis experiment is described in detail in Section 6 (page 7).

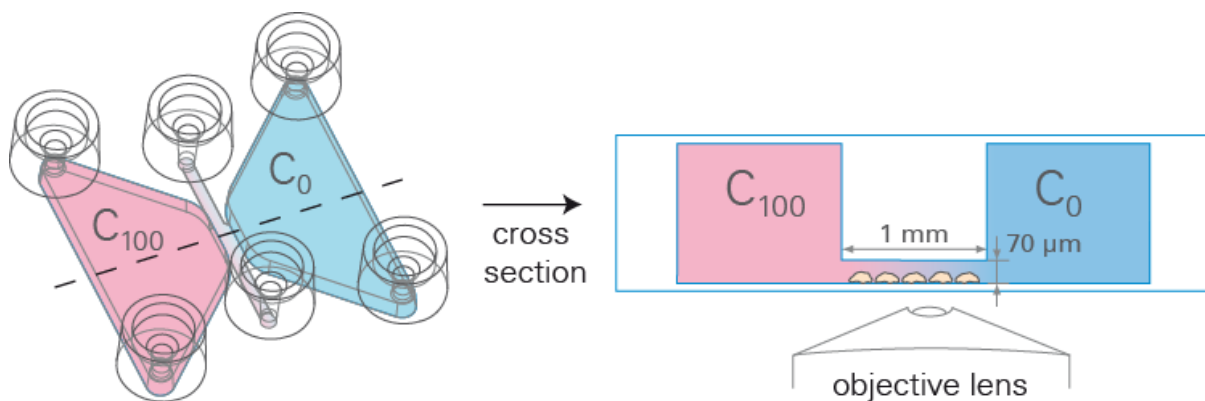

3 Equipment

When conducting chemotaxis experiments with the μ -Slide Chemotaxis, it is 100% necessary to use the following materials and equipment:

- Cells and a gel matrix suitable for the cells.
 - See [Application Notes 23, 24 and 34](#) for example chemotaxis experiments, [Application Note 26](#) for example protocols for Collagen I gels and more Application Notes on www.ibidi.com.
 - Recommended gel matrices:
 - Collagen I gels, bovine or rat tail
 - Matrigel™ or similar products
- A humid chamber, such as a 10 cm Petri dish with wet tissue (as shown on the right)
- Optimal conditions for the cells (Heating & Incubation System)
- An inverted microscope (phase contrast or fluorescence)
- Time lapse video equipment: camera and acquisition software
- Use only the correct 10 - 200 μ l pipet tips (others do not work).
 - Greiner Bio-One 739261, 739280, 739290, 772288, or related beveled Greiner tips
 - Axygen T-200-C, TR-222-C, TR-222-Y, or related Axygen beveled tips
 - STARLAB TipOne RPT S1161-1800, or related beveled TipOne tips
 - Sorenson BioScience Multi Fit Tip 10590, 15320, 15330
- Slant cosmetics tweezers, for plug handling
- Optional: Motorized stage and autofocus (x,y,z), to observe all 3 chambers, in parallel

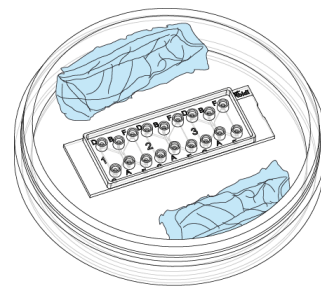

Humid Chamber
With wet sterile tissue.



Beveled Pipet Tip
See list for correct models

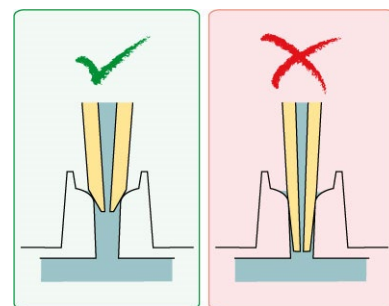

Correct Tip

- Fits on top
- Closes completely
- Does not get stuck

Incorrect Tip

- Fits too tightly

4 Surfaces and Coatings

4.1 ibiTreat (80326)

The ibiTreat (hydrophilic) surface facilitates the filling of the structure, with aqueous gels for 3D assays.

4.2 Collagen IV Coated Surface (80322)

The Collagen IV pre-coated slides do not contain a collagen gel. Only the surface is coated with Collagen IV to mediate cell adhesion for 2D chemotaxis experiments.

Other surface coatings can be made by following Application Note 08:

https://ibidi.com/img/cms/support/AN/AN08_Coating.pdf



Slant Tweezers
For convenient plug handling

5 3D Experiment with Cells in Gel

5.1 Seeding Cells in a Gel Matrix

- 1) Unpack the μ -Slide Chemotaxis and put it into a 10 cm Petri dish with a sterile, wet tissue around the slide. This helps to decrease the evaporation.
- 2) Prepare cell suspension, as usual.
- 3) Prepare gel matrix. Example gel protocols are given AN 26 (Collagen I Protocols).
- 4) Mix the cell suspension and gel mixture to a final cell concentration of ca. 3×10^6 cells/ml. High cell concentrations are needed, due to the small height of the observation area.
- 5) Close Filling Ports C, D, E, and F with the plugs. Handle the plugs with the appropriate blunt tweezers.
- 6) Use a 20 μ l pipet (e.g., Gilson P-20) and apply 6 μ l of gel mixture to the top of Filling Port A, leaving space between the tip and the port. We do not recommend injecting the gel directly. See note 12.1.
- 7) Immediately afterwards, use the same pipet settings (6 μ l) and aspirate air from the opposite Filling Port B. Press the pipet tip directly into the port. The liquid gel from Filling Port A will be flushed inside, filling the entire channel homogeneously. Aspirate until the liquid gel reaches the pipet tip.
- 8) Leave both Filling Ports A and B filled with gel. If necessary, level out the liquid heights in both filling ports, as shown in the cross section.
- 9) Gently remove all plugs from Filling Ports C, D, E, and F. Close Filling Ports A and B with plugs.
- 10) Incubate the slide inside a sterile and humid atmosphere to minimize evaporation until the gel is formed. To make sure evaporation is low, use a sterile 10 cm Petri dish with an extra wet tissue around the slide (see Humid Chamber, on page 4).
- 11) Control the cell morphology with a microscope during and after gelation (see the Note: Cell Morphology, on page 17). Check the amount of gel in the channel and Filling Ports A and B to control the evaporation.

The day before seeding the cells and conducting the experiment, it is necessary to place all cell culture media, the μ -Slide, and plugs into the incubator for gas equilibration. The medium should be put into a slightly opened vial. This will prevent the medium inside the slide, and the slide itself, from allowing air bubbles to form during the incubation time.

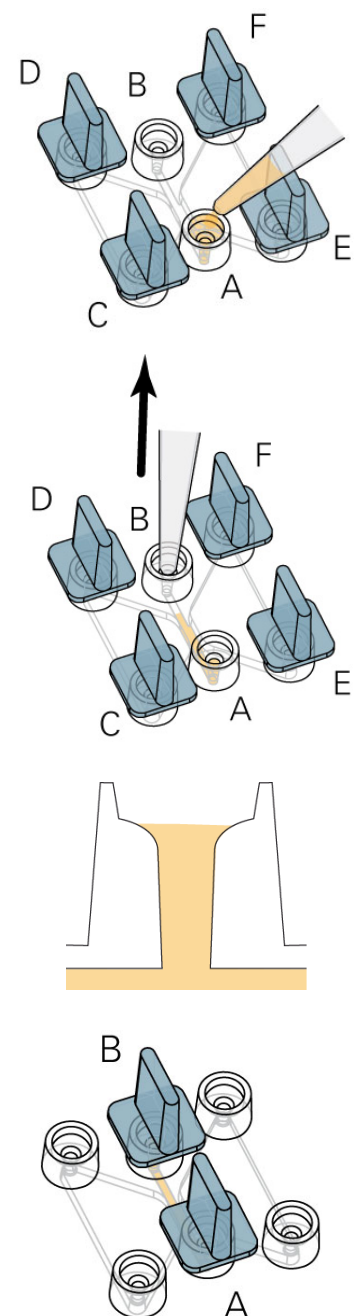

5.2 Filling the Reservoirs

Both large reservoirs are first filled with neutral solution. Next, the chemoattractant is applied without directly reaching the observation area.

As a result, there is a short delay in the gradient formation and sensitive cells cannot be initially saturated. The resulting concentration in the reservoir is 0.5 times the injected concentration, because 30 μ l chemo-attractant is diluted with 30 μ l of neutral solution.

- 1) Gently close Filling Ports C and D with plugs (chemoattractant side).
- 2) Fill the first reservoir by injecting chemoattractant-free medium through Filling Port E. Use 65 μ l and the recommended pipet tips. Keep in mind that Filling Ports E and F must be completely filled, but not overfilled.
- 3) Transfer the two plugs from the Filling Ports C and D to the Filling Ports E and F. This will close the chemoattractant-free side.
- 4) Fill the empty reservoir by injecting chemoattractant-free medium through Filling Port C. Use 65 μ l and the recommended pipet tips.
- 5) Now the chamber is completely filled with chemoattractant-free medium and cells will only grow inside the gel in the observation area. Control your cells under the phase contrast microscope.
- 6) Use a 20 μ l pipet (e.g. Gilson P-20) and apply 15 μ l chemoattractant to the top of Filling Port C, as shown. Do not inject directly.
- 7) Use the same pipet settings and aspirate 15 μ l liquid from the opposite Filling Port D. Press the pipet tip directly into Filling Port D. The chemoattractant on top of Filling Port C will be flushed inside and fill the reservoir.

Control the quality of the gel and the cells after each filling step under the phase contrast microscope.

Handle the liquid with care not to destroy or detach the gel matrix by too much pressure.

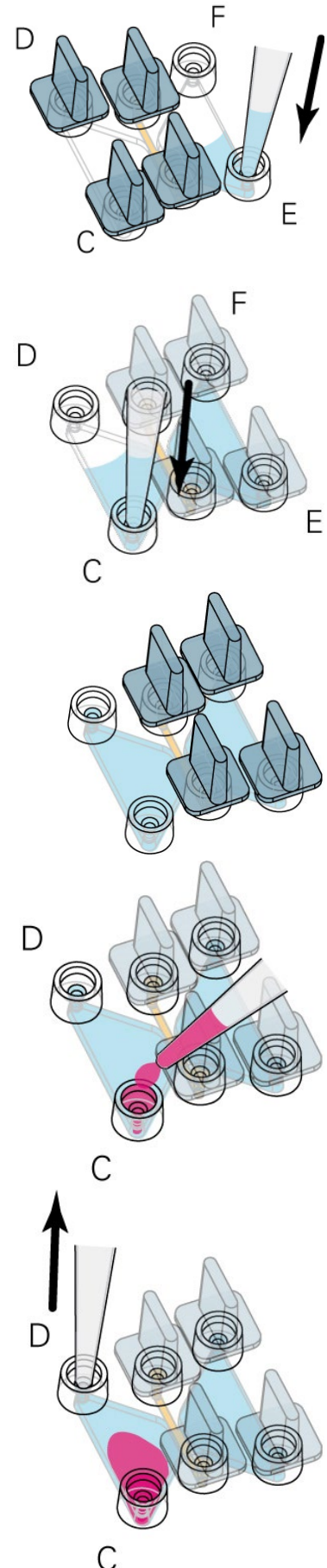

- 8) Repeat this step once again, in order to fill 30 μl inside the reservoir. Keep in mind that food coloring with a high sugar concentration is not intended to visualize the gradient formation.
- 9) Gently close all Filling Ports.
- 10) The resulting concentration in the reservoir is 0.5 times the injected concentration, because 30 μl of chemoattractant is diluted with 30 μl of neutral solution.

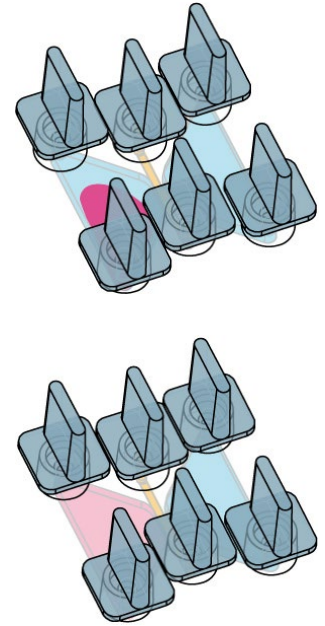

6 2D Experiment with Cells on a 2D Surface

6.1 Seeding Cells

- 1) Unpack the μ -Slide Chemotaxis and put it into a 10 cm Petri dish with a sterile, wet tissue around the slide to decrease evaporation.
- 2) Prepare your cell suspension, as usual. Use a cell suspension of approx. 3×10^6 cells/ml. High cell concentrations are needed due to the small height of the observation area.
- 3) Close Filling Ports C, D, E, and F with plugs. Handle plugs with the appropriate slant tweezers.
- 4) Use a 20 μl pipet (e.g. Gilson P-20) and apply 6 μl cell suspension onto Filling Port A. Do not inject directly.
- 5) Immediately afterwards, use the same pipet settings (6 μl) and aspirate air from the opposite Filling Port B. Press the pipet tip directly into the port. The liquid from Filling Port A will be flushed inside, filling the entire channel homogeneously. Aspirate until the cell suspension reaches the pipet tip. Leave both Filling Ports A and B filled with liquid. If necessary, level out the liquid heights in both Filling Ports, as shown.

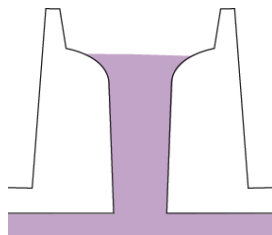

- 6) Gently remove all plugs from Filling Ports C, D, E, and F. Close the slide with the cultivation lid.

The day before seeding the cells and conducting the experiment, it is necessary to place all cell culture media, the μ -Slide, and plugs into the incubator for gas equilibration. The medium should be put into a slightly opened vial. This will prevent the medium inside the slide, and the slide itself, from allowing air bubbles to form during the incubation time.

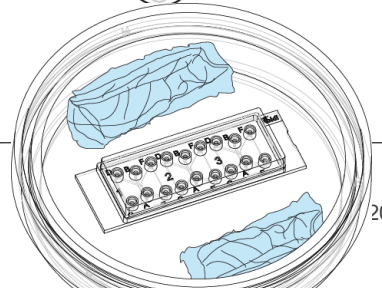
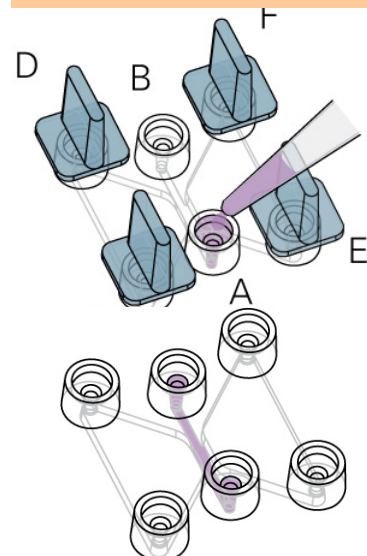

- 7) Incubate the slide inside a sterile and humid atmosphere to minimize evaporation until the cells have attached. Make sure evaporation is low by using a sterile 10 cm Petri dish with an additional wet tissue placed around the slide.

6.2 Cell Attachment

During and after cell attachment, control cell morphology with a microscope. To control evaporation, check the amount of liquid in the channel and Filling Ports A and B. Cell attachment should occur in same time as in normal culture.

After cell attachment, the removal of the non-adherent cells and seeding medium is recommended. (Skip this step when you are working with cells that are only slightly adherent.)

Follow these steps:

- 1) Gently close Filling Ports C, D, E, and F with plugs (not shown).
- 2) Add 10 μ l of cell-free medium onto Filling Port A. Do not trap any air bubbles. Do not inject directly.
- 3) Aspirate the same amount of liquid (10 μ l) from Filling Port B, as shown.
- 4) Repeat Step 2 and 3.
- 5) Leave both of the Filling Ports A and B filled with liquid. If necessary, level out the liquid heights in both Filling Ports.
- 6) Gently remove all plugs from Filling Ports C, D, E, and F. Close Filling Ports A and B with plugs.

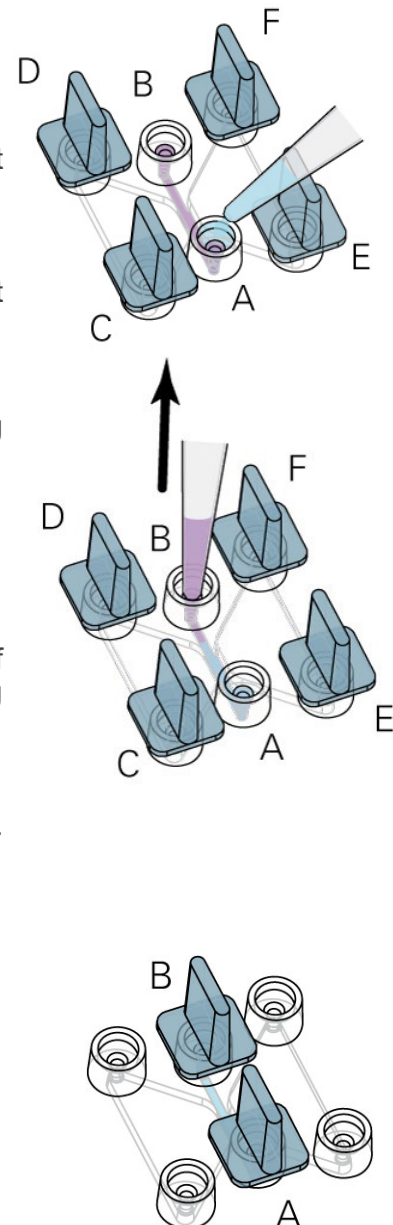

Filling the Reservoirs

- 1) Gently close Filling Ports C and D with plugs (chemoattractant side).
- 2) Fill the first reservoir by injecting a chemoattractant-free medium through Filling Port E. Use 65 μl and the recommended pipet tips. Keep in mind that the Filling Ports E and F must be completely filled, but not overfilled.
- 3) Transfer the two plugs from the Filling Ports C and D to Filling Ports E and F to close the chemoattractant-free side.
- 4) Fill the empty reservoir by injecting chemoattractant-free medium through Filling Port C. Use 65 μl .
- 5) Now the chamber is completely filled with chemoattractant-free medium and cells grow only in the observation area. Control your cells under the phase contrast microscope.
- 6) To apply a chemoattractant, use a 20 μl pipet (e.g. Gilson P-20) and apply 15 μl chemoattractant on top of Filling Port C, as shown. Do not inject directly.
- 7) Use the same pipet settings and aspirate 15 μl liquid from the opposite Filling Port D. Press the pipet tip directly into Filling Port D. The chemoattractant on top of Filling Port C will be flushed inside and fill the reservoir.
- 8) Repeat steps 6 and 7 once again, in order to fill 30 μl inside the reservoir.
- 9) Gently close all Filling Ports.
- 10) The resulting concentration in the reservoir is 0.5 times the injected concentration, because 30 μl of chemoattractant is diluted with 30 μl of neutral solution.

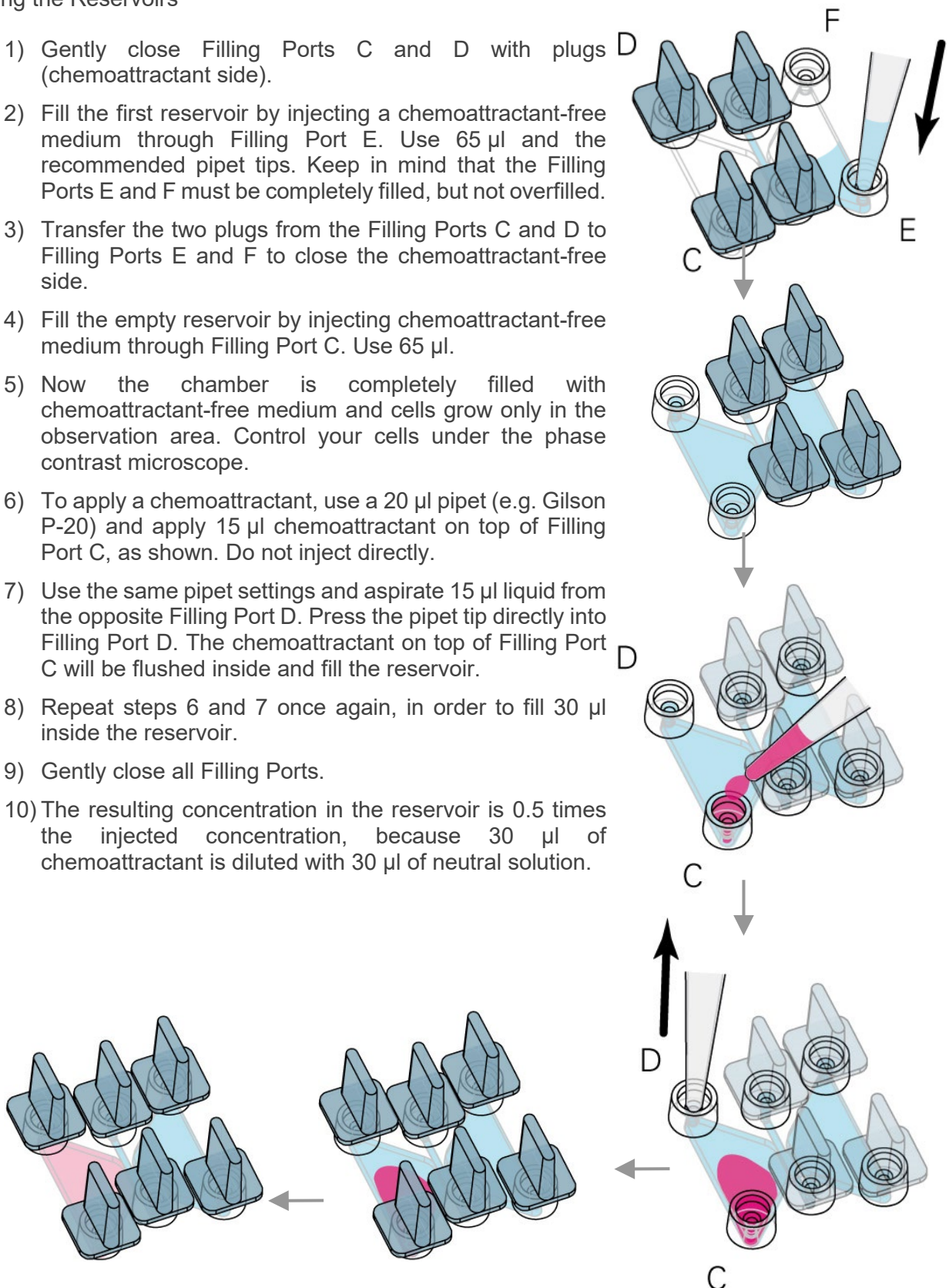

7 Video Microscopy

Video microscopy is a necessary tool for ibidi's μ -Slide Chemotaxis. Without, there is no access to the analysis of the chemotaxis and migration effects.

- 1) Prepare your inverted microscope and stage-top incubator. Depending on your cells' requirements, the use of heating and incubation devices may be necessary, e.g. ibidi Heating & Incubation System. Working at room temperature with cells that are usually cultured at 37°C is not recommended.
- 2) Mount the μ -Slide on the stage, then observe cell movement within the observation areas. Depending on the cells' velocity, one frame every 1-10 minutes should be sufficient. In order to track cells conveniently, make sure to have an overlap of each moving cell from one frame to the next.
- 3) After mounting the slide on the microscope stage, wait 20 minutes for temperature equilibration.
- 4) Observe cell movement for an appropriate time. Depending on the cells' velocity at least 10 cell diameters are recommended. For fast cells this might be 1-2 hours and for slow migrating cells 12-36 hours, respectively.
- 5) Start a time-lapse experiment with a 5x or 10x objective. Higher magnifications are possible but for optimal migration data it is necessary to track at least 20 – 40 cells over the whole period. Start the experiment as soon as the temperature is stable. See Note 12.5 Optimizing Experimental Time.
- 6) After the time-lapse, export your images as single files (e.g. TIF, JPG, PNG, BMP).

Depending on your focus of interest, choose an objective lens:

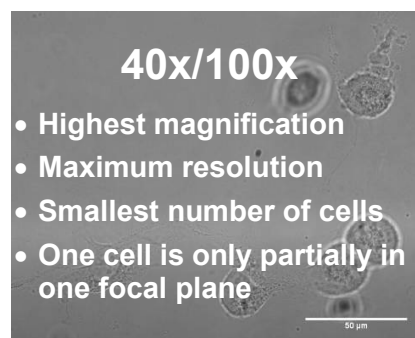
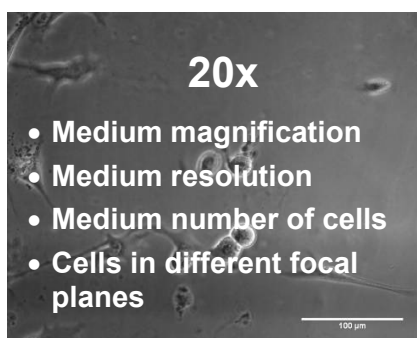
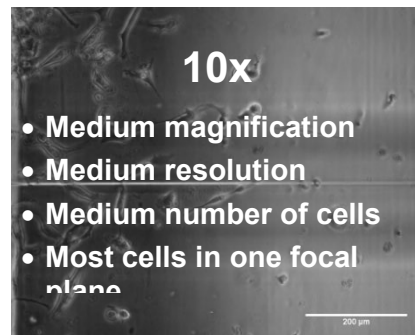
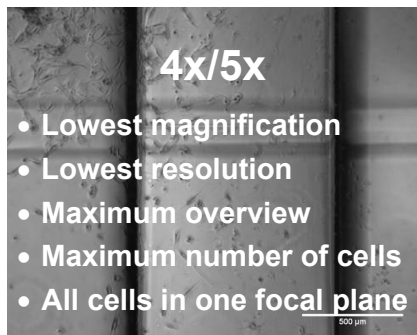

8 Chemoattractant Concentrations and Recommended Experimental Setups

For optimal results, we recommend performing two control experiments by filling the chamber completely with chemoattractant solution or neutral solution, respectively. This helps determine if a compound is influencing the directed movement of cells (chemotaxis) and/or is influencing random migration (chemokinesis).

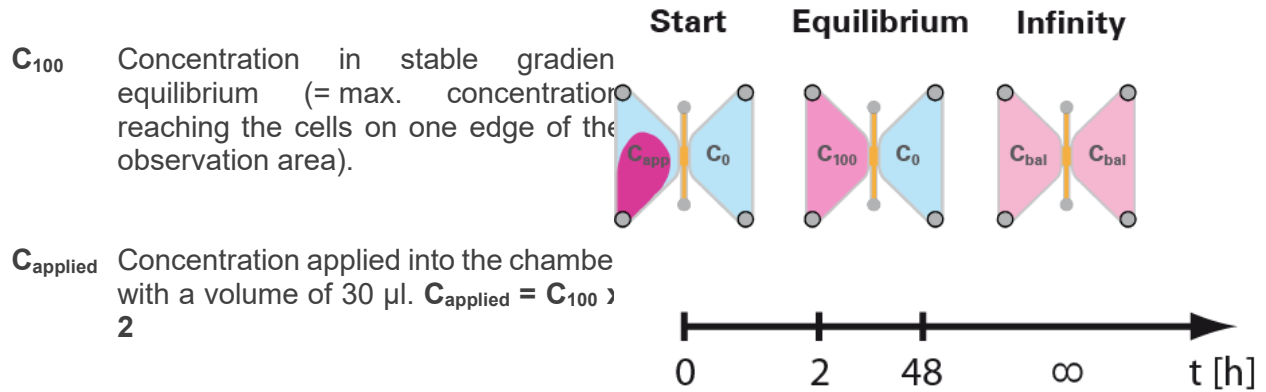

C₁₀₀ Concentration in stable gradient equilibrium (= max. concentration reaching the cells on one edge of the observation area).

C_{applied} Concentration applied into the chamber with a volume of 30 µl. $C_{applied} = C_{100} \times \frac{30}{130}$

C_{balanced} Balanced chemoattractant concentration after an infinite time calculated with the total chamber volume of 130 µl.

$$C_{balanced} = C_{applied} \times 30 \mu l / 130 \mu l$$

C₀ Solution without (or with a low concentration) of chemoattractant.

For the +/- control experiment, remember to also prepare the gel with the chemoattractant solution C_{bal}.

Recommended setup for one slide:

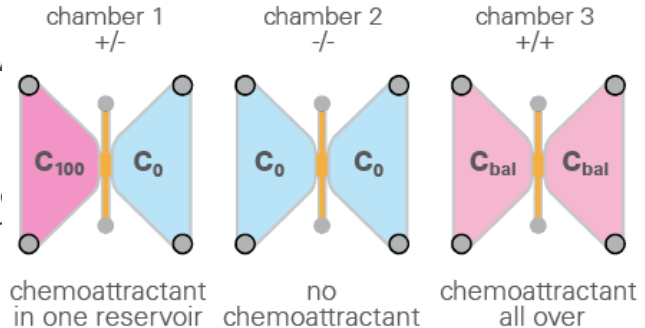

When following the very special “Fast Method” of chemoattractant filling method from Note 12.4 the chemoattractant is not diluted at all. In this case $C_{applied} = C_{100}$.

9 Tracking Cells as a 2D Projection

When cells migrate through a 3D matrix, we recommend tracking them as a projection into the x-y plane. This simplifies analysis, and is considered to be correct in a channel with an aspect ratio of 10:1 (length:height), or bigger. After the experiment, it is necessary to track the cells with the appropriate software. We recommend, for example, the ImageJ plugin, Manual Tracking. This plugin is able to quantify the movement of objects between frames of a temporal stack (see Note 12.3: Cell Tracking, on page 17).

- ImageJ is available here: <http://rsb.info.nih.gov/ij/>

- The Manual Tracking plug-in (including a PDF documentation) by Fabrice Cordelières, Institut Curie, Orsay, France is available here:
<http://rsbweb.nih.gov/ij/plugins/track/track.html>
- Download Manual_Tracking.class into the plugins folder of ImageJ on your computer and restart ImageJ. Make sure you have administrator rights.

Here is a quick guide for tracking with the Manual Tracking tool:

- 1) Import a movie as single page image files (e.g. TIF, JPG, PNG, BMP, by using „File/Import/Image_Sequence“).
- 2) Open plugin “Manual Tracking”.
- 3) Select “Add track”.
- 4) Follow the first cell, through all of the time points, by clicking on the cell’s midpoint. After the first click, the software creates the results table in an extra window. This table is filled with the x/y data of each cell, at each time point.
- 5) Save the data table after tracking is completed (tab-separated .xls file).
- 6) The data table contains all tracked cells (=tracks) and time points (=slices) with x,y positions.

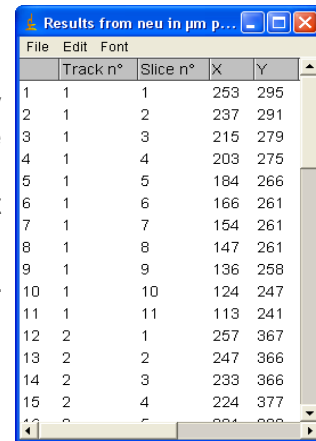

	Track n°	Slice n°	X	Y
1	1	1	253	295
2	1	2	237	291
3	1	3	215	279
4	1	4	203	275
5	1	5	184	266
6	1	6	166	261
7	1	7	154	261
8	1	8	147	261
9	1	9	136	258
10	1	10	124	247
11	1	11	113	241
12	2	1	257	367
13	2	2	247	366
14	2	3	233	366
15	2	4	224	377
16	2	5	204	388

- For tracking, we recommend printing out the first image of each image stack before the movie is watched for the first time. At least 40 cells are uniformly marked on this printout in order to 1) ensure homogeneity and 2) avoid tracking the same cell twice. At least 20-40 cells in the observation field need to be tracked during the entire experiment. Some cells will be lost through cell death, cell division, and cells leaving the observation field. We do not recommend using such cells for data analysis.
- You can also export “Overlay Dots & Lines” as a movie file (.avi).

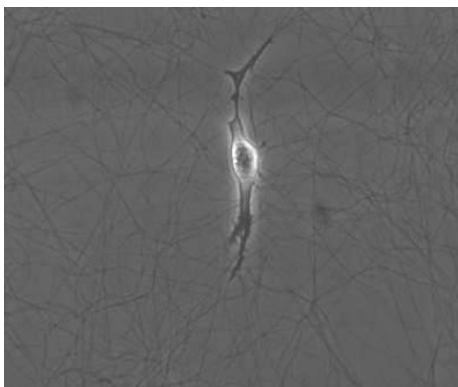

HT-1080 fibrosarcoma cell migrating inside a Collagen I gel.

Analyzing Chemotaxis

9.1 Data Analysis

ibidi provides a free software tool for plotting and analyzing the tracked data. For a copy, go to: <https://ibidi.com/chemotaxis-analysis/171-chemotaxis-and-migration-tool.html>.

Please also read the pdf instructions for the software Chemotaxis and Migration Tool.

- 1) Import the data table from “Manual Tracking” (tab-separated .xls file)
- 2) Initialize your dataset in the initialization menu on the lower right side of the software.
 - Select the number of slices (=number of pictures used for tracking). The number of slices can be found in your original data table (“Show original data”).
 - Calibrate the software by setting the x/y calibration. This is the length of one pixel in μm . The pixel size can be measured following our [Application Note 22](#) on www.ibidi.com.
 - Calibrate the time interval which is the time between the images of your video.
- 3) Press “Apply settings”, after changing values and parameters.
- 4) Create trajectory plot, and then export as an image.
- 5) Export values of both Forward Migration Indices and the p-value of the Rayleigh test.
- 6) Convert Forward Migration Index x and y into FMI parallel (FMI II) and FMI perpendicular (FMI \perp), depending on the position of your chemoattractant. This simplifies the analysis and presentation of the FMI data.
- 7) Calculate a two-tailed unpaired Student t-test (e.g. with MS Excel) with independent variances for the single values from 5). Compare the chemotaxis experiment +/- and the two control experiments -/- and +/+ with each other to show statistical significance.

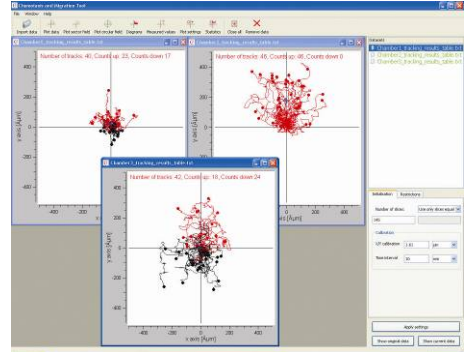

9.2 Criteria for a Chemotaxis Effect

If the following criteria are fulfilled with statistical relevance the experiment is considered to show a chemotaxis effect.

Experiment +/-

- FMI II > FMI \perp
- Rayleigh test: $p < 0.05$

Control Experiment +/+ and -/-

- FMI \perp and FMI II = ca. 0
- Rayleigh test: $p > 0.05$

9.3 Presenting Results

Here are some recommendations for presenting the results (in talks or publications):

- Show the original movie (time lapse film of your cells).
- Play the trajectory movie (time lapse film + overlaid cell trajectories).
- Display the trajectory plot (graph).
- Show the table or bar graph FMI, and Rayleigh test.
- Include the results of the Student's t-test.

10 Tips, Tricks, and Troubleshooting

10.1 Avoiding Air Bubbles

Air bubbles are 1) emerging over time due to non-equilibrated media and slides, or are 2) injected, or brought into the chamber, by the user. Both types will disturb the diffusion-driven concentration gradient with convection and must be avoided.

- Air bubbles that emerge over time can be avoided by equilibrating all media and equipment inside the incubator overnight. Medium is put into a slightly opened vial. Slides and plugs can be left in the sterile packaging.
- Air bubbles introduced to the chamber by injection, or by the user, can be avoided by correct handling. Please avoid unfilled Filling Ports and trapped air bubbles inside the pipet tip! Keep in mind that an air bubble might be trapped when closing an empty Filling Port with a plug. Always make sure that the Filling Ports are completely filled, but not overfilled. When filling the large reservoirs, always inject the liquid into the lower reservoir in order to allow the lighter air to escape on the top.

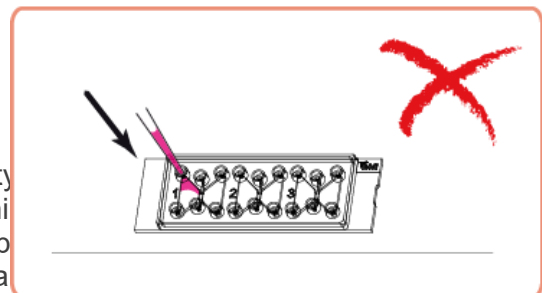
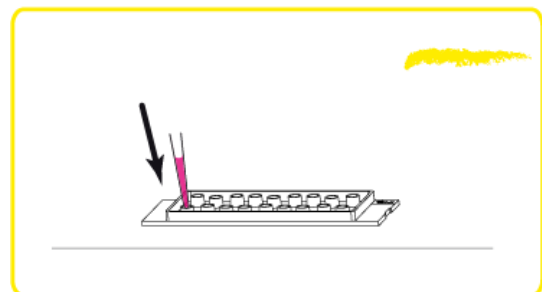
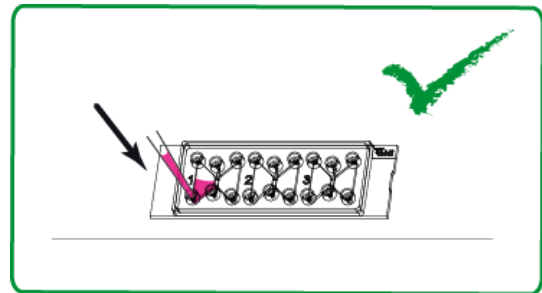
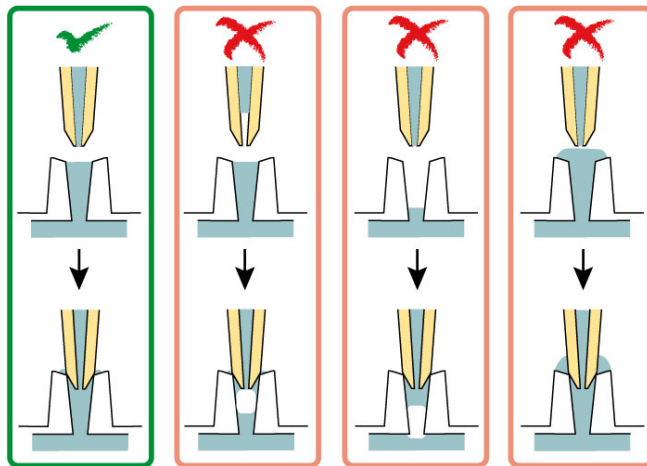

Avoid unfilled filling ports and air bubbles inside the pipet tip!

Filling Ports that are accidentally emptied, or left empty can be refilled with a 10 μ l pipet that has a very thin pipet tip. Note: Never use the standard-sized pipet tip for this procedure, but use the next smallest size. An air bubble might be trapped.

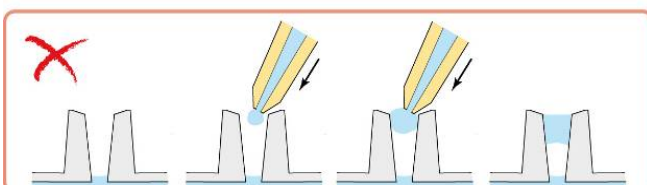
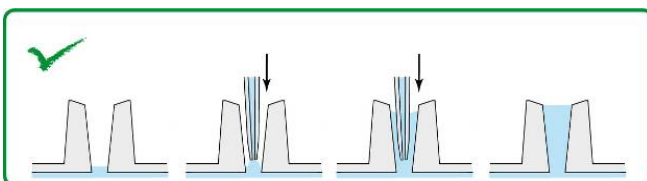

Avoid trapping air by filling empty reservoirs with the μ -Slide inclined. Always inject the liquid into the lower reservoir in order to allow the lighter air to escape on the top.

10.2 Focus Not Stable

Focus drift is an annoying effect, especially during time lapse experiments. Focus stability is negatively affected by mechanical changes and temperature instabilities. Follow these recommendations to keep your cells in focus:

- Switch on all components (heating, gas incubation, computer, other equipment) at least 60 minutes before starting the time-lapse recording.
- After you put the μ -Slide onto the microscope, wait 20 minutes before starting a time lapse experiment to achieve temperature (and immersion oil) equilibration.
- Keep the room temperature as stable as possible. Air conditioning should either be working continuously or switched off completely.
- Do not change the temperature during experiments. Avoid being near door and window openings, as this could rapidly change the temperature.
- Eliminate all sources of mechanical vibrations. Use a damped table for your microscope.
- Use an autofocus system.

10.3 Chamber Not Filling Properly

Here are some general tips and tricks for filling the chamber:

- Always use chambers that are completely dry, especially after coating the chambers. Small amounts of remaining liquid might hinder proper handling.
- Use a pipet that is serviced routinely. After a few years of use, pipets can loose pressure during pipetting. In normal work they might perform well, but there can be problems when they are used with the μ -Slide Chemotaxis.
- During the filling of liquid by injection, incline the slide in a way that the liquid is beneath air. By doing this, the lighter air can escape through the filling port above.

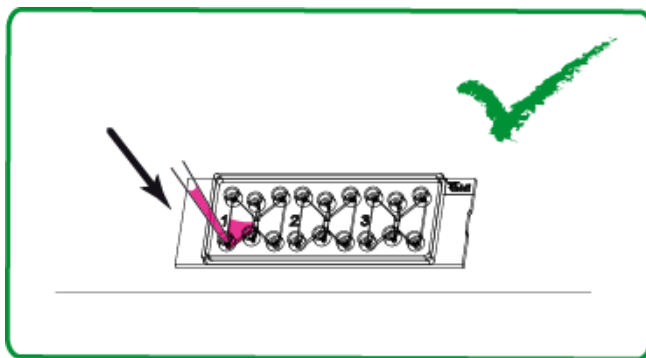

10.4 Cells Die in the Gel Matrix

pH and salt concentrations can cause many problems in gel matrices. Please test your gel protocol with your cells in an environment suited for this purpose. We recommend small open wells, such as μ -Slide Angiogenesis, where the cells can be seeded in a larger volume. This way the perfect matrix composition for the cells can be tested in a convenient manner.

10.5 Cells Do Not Migrate in Gel

To help find a solution, here are some questions to ask:

- *Are the cells seeded in an optimal growth medium?*
- *Is the pH in an optimal range for the cells?*
- *Can the cells degrade the gel matrix?*
- *Is the concentration of gel too high? Is the gel too stiff?*
- *Are there suitable binding motifs for cell attachment?*

As a first trial, we recommend using a 1.5 mg/ml Collagen I gel. Please find a detailed protocol in our Application Note 26 on www.ibidi.com.

10.6 Matrix not Homogeneous, Inconsistent Gel or Fibers with Preferred Direction

Inhomogeneities in gel matrices should be avoided in any case to create consistent migration data. In general, mix the gel itself and then the gel-mix with the cell suspension very well. Take your time for mixing. Excessive up- and downpipetting is necessary; also in combination with stirring with the pipet tip. Also make sure to use freshly aliquoted and non-expired ingredients only.

For Collagen Gels:

The two crucial parameters are homogeneity of the mixture in the beginning and the temperature during filling the chamber. Make sure to mix the viscous collagen mix very well and take your time for mixing. Unlike normal solutions the collagen-cell-mix does not mix by itself by diffusion. After some time the collagen mix starts to gel. This beginning gelation can lead to preferred fibers directions in small channels and can be avoided by a) shortening the working time or b) working on ice to slow down the gelation process.

10.7 Cells Do Not Attach Properly (2D Assay Only)

The chamber's geometry is very specialized. The cell seeding step is especially critical, because the volume is very low. Most problems with cell attachment can be avoided by checking these following facts:

- *Are the cells seeded in optimal growth medium?*
Adherent cells will not attach properly when they are seeded in a starvation medium. Use normal growth medium with all the necessary supplements.
- *Is the slide put into an extra humid chamber?*
Evaporation is one of the most crucial issues during cell attachment. Make sure to provide a maximum of humidity during cell attachment. Use a 10 cm Petri dish with wet tissue.
- *Is the incubator frequently opened during the cell attachment phase?*
Frequent door openings must be avoided because this drastically lowers humidity inside the incubator for a time. Use a cell culture incubator that is not being used by others during cell attachment.

10.8 Inhomogeneous Cell Distribution (2D Assay Only)

Inhomogeneous cell distribution, and especially high cell densities close to the observation area, negatively overlay directed migration and must be avoided. Carefully conduct all of the steps in this Application Note to avoid spilling cell suspension into the reservoirs. Never inject cell suspension directly into the filling ports.

10.9 Low reproducibility of results

In years of experimental work we found that only 3 experiments with ca. 40 cells are necessary for highly significant and reproducible data. In case the chemotactic parameters like Forward Migration Indices or Velocity differ strongly from identical experiments, one of the following points might be the reason for that.

- *Homogeneous Gel Matrix*

The gel matrix is one of the most crucial issues during chemotaxis. See 11.5 and 11.6 for troubleshooting.

- *Reproducible Protocol*

Slightly different handling and gel protocols may be the source of low reproducibility. For some gel protocols, the order of pipetting is crucial. The order of using the plugs may also be crucial. For most reproducible results we do not recommend the so-called “Fast Method” anymore. See 12.4.

- *Correct Concentration of Substances in Gel and Reservoirs*

In chemotaxis experiments the end-concentration of substances like salt, buffer, serum etc. should be homogeneous, especially between gel and C_0 solution. Moreover, in a +/+ experiment with chemoattractant all over, the gel itself needs to be made with the identical end-concentration of chemoattractant used in the large reservoirs. Otherwise competing gradient fields are created which may disturb directed movements of cells.

- *Homogeneous Population of Cells*

Some cells need to be derived with a special protocol, a transfection method or a special differentiation. Normally, this treatment leads to inconsistent cell populations or inconsistent migration behavior.

11 Notes

11.1 Note: Gel Filling

Gel mixture is filled in a faster way when directly injected into the channel. After injecting a small amount of gel, the channel is filled. Afterwards, it is necessary to suck out the gel from the opposite filling port, until both ports are equally filled. This procedure needs to be done with extreme caution to avoid spilling any gel mixture into the large reservoirs. When done correctly, this method doesn't need plugs to fill the gel inside the chamber.

11.2 Note: Cell Morphology

Cells should be completely surrounded by the 3D gel. Adherent cells might sink down and attach to the 2D surface with time, due to durotaxis. Please make sure to clearly distinguish between

cells adhered to surfaces (typically spread out), and cells which are in 3D (typically spherical or spindle-like).

11.3 Note: Cell Tracking

Tracking cells can also be done with different software programs or algorithms. Please also visit www.ibidi.com for an automated tracking solution.

11.4 Note: Chemoattractant filling with “Fast Method”

With the “Fast Method”, replacing the sections 5.2 or 6.3, one large reservoir is completely filled with the chemoattractant. Following this protocol is easier but may lead to inconsistencies by flushing chemoattractant into the gel directly. The downside of this method is, that sensitive cells may initially be saturated with the chemoattractant.

- 1) Gently close Filling Ports C and D with plugs (chemoattractant side).
- 2) Fill the first reservoir by injecting chemoattractant-free medium through Filling Port E. Use 65 μ l and the recommended pipet tips. Keep in mind that Filling Ports E and F must be completely filled, but not overfilled.
- 3) Transfer the two plugs from Filling Ports C and D to Filling Ports E and F. This will close the chemoattractant-free side.
- 4) Inject 65 μ l of chemoattractant into Filling Port C, as shown. Do not trap air bubbles. Note: The chamber is now completely filled and cells are only kept inside the gel in the observation area.
- 5) Close the Filling Ports C and D with plugs (chemoattractant side).
- 6) Control your cells under the phase contrast microscope. Note: The chemoattractant will immediately diffuse through the observation area and establish a linear concentration profile over the cells.

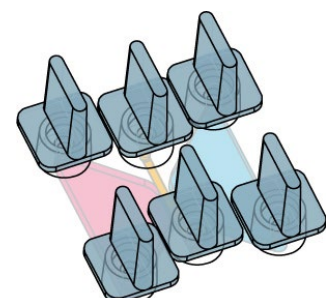
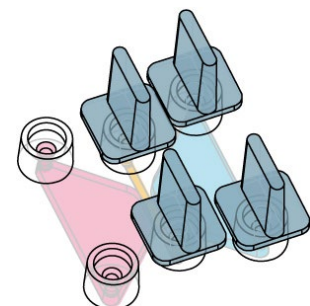
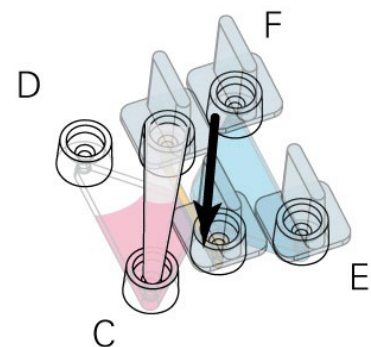
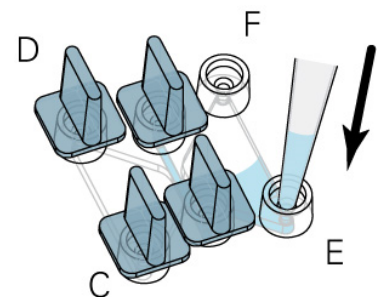

11.5 Note: Optimizing Experimental Time

For optimal migration data of migrating cells, we recommend an initial experiment to determine the optimal experimental time.

- 1) Start the experiment immediately after injecting the chemoattractant.
- 2) Observe cell movement over a rather long time. For fast migrating cells this might be 4 hours, for slow migrating cells this might be 36 hours.
- 3) Split the output data set (single images) into appropriate time sections. Make sure to choose time sections long enough to ensure cells migrate at least 10 cell diameters

on average and short enough that cells stay inside your microscopic field. For fast migrating cells this might be 1 hour, for slow migrating cells this might be 12 hours.

- 4) Track and analyze each time section separately. Check for a time-dependent chemotaxis effect or time-dependent cell behavior.
- 5) After this initial experiments, choose your optimized experimental time.