

# IKA

designed for scientists

## **IKA C 6000 global standards IKA C 6000 isoperibol**



Operating instructions  
Source language: German

EN

## Device setup

### Front



- 1: Lift
- 2: RFID sensor field for decomposition vessel detection
- 3: Decomposition vessel
- 4: Touch screen
- 4a: Interface for USB (stick and printer)
- 5: Mains switch

Fig. 1

### Back



- 6: Interfaces for PC communication (Balance/Ethernet/USB/Sample Rack)
- 7: Water filter
- 8: Main fuses
- 9: Mains socket
- 10: Condenser/thermostat inlet (IN)
- 11: Condenser/thermostat outlet (OUT)
- 12: Discharge hose (EMPTY)
- 13: Oxygen supply (IN)
- 14: Vent (OUT)

Fig. 2

### Internal structure

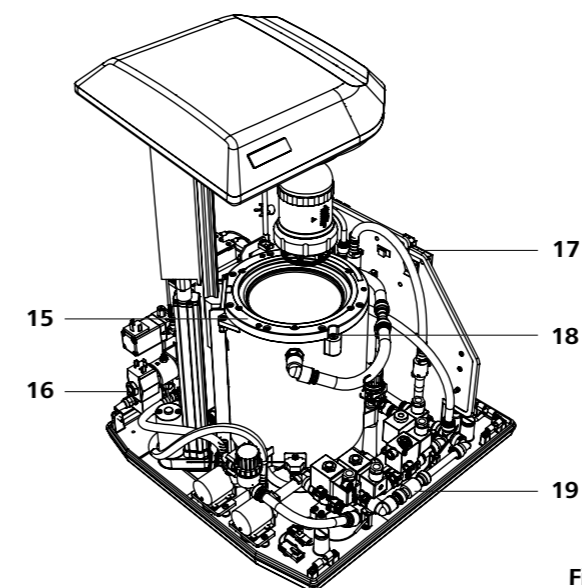

- 15: Vessel group (inner vessel and outer vessel)
- 16: Valve group, oxygen and degassing
- 17: Electronics
- 18: Vent screw
- 19: Valve group, water

Fig. 3

## Dangerous spots



Fig. 4

## Content

	Page
<b>1 Declaration of conformity</b>	<b>06</b>
<b>2 Warranty</b>	<b>06</b>
<b>3 Warning symbols</b>	<b>06</b>
<b>4 Safety instructions</b>	<b>07</b>
<b>5 Correct use</b>	<b>09</b>
5.1 Use	09
5.2 Area of use	09
5.3 Recommended method of operation in working mode	09
<b>6 Useful information</b>	<b>10</b>
6.1 Determining the calorific value	10
6.2 Corrections	10
6.2.1 Acid correction	10
6.3 Note on the sample	11
6.4 Complete combustion	12
6.5 Adjustment	12
6.6 Calibration	12
6.7 System properties	13
<b>7 Transport and unpacking</b>	<b>13</b>
7.1 Transport	13
7.2 Unpacking	13
7.3 Scope of delivery	13
<b>8 Setting up and assembly</b>	<b>14</b>
8.1 Place of installation	14
8.2 Assembly of the attachments	14
8.2.1 Condenser/thermostat	14
8.2.2 Water supply line	15
8.2.3 Oxygen supply	15
8.2.4 Venting hose	15
8.2.5 Mains power supply	15
8.2.6 Peripheral devices	16
8.2.7 Mains switch	16
<b>9 Operator panel and display</b>	<b>17</b>
9.1 Explanation of the display	17
9.2 Status symbols	17
<b>10 Commissioning</b>	<b>18</b>
10.1 Switching on	18
10.2 System test	18
10.3 Switching off	18
10.4 Menu structure	19
10.5 Menu details, main menu	20
10.6 Touch screen input field	20
<b>11 Operation</b>	<b>21</b>
11.1 Procedure	21
11.2 Decomposition vessel	21
11.2.1 Creating a decomposition vessel	21
11.2.2 Editing a decomposition vessel	21
11.2.3 Calibration	22
11.3 Modules (peripheral devices)	21
11.3.1 Balance	23
11.3.2 Sample rack	24
11.3.3 Printer	25

11.4 Settings	26
11.4.1 Setting the language	26
11.4.2 Measurement settings	26
11.4.3 Creating ignition and combustion aids	27
11.4.4 Selecting the unit	27
11.4.5 Selecting the Reference combustion value	28
11.4.6 Creating users	28
11.4.7 Report	28
11.4.8 Setting the date and time	28
11.4.9 Audio settings	29
11.5 Carrying out a measurement	29
11.5.1 Creating a measurement	29
11.5.2 Editing a measurement	29
11.5.3 Simulation	30
11.5.4 Starting a measurement	30
11.5.5 Measurement procedure	31
11.6 Archive	31
11.6.1 Selecting a measurement in the archive	31
11.6.2 Editing a measurement in the archive	31
11.6.3 Opening a completed measurement	32
11.6.4 Evaluating a measurement	32
11.7 Maintenance	32
11.7.1 Maintenance programs	33
11.8 Information	34
<b>12 Maintenance and cleaning</b>	<b>34</b>
12.1 Cleaning the system	34
12.1.1 Cleaning a decomposition vessel	34
12.1.2 General maintenance and cleaning	34
12.1.3 Emptying water	35
12.2 Maintenance and cleaning of water filters	35
<b>13 Error codes</b>	<b>36</b>
<b>14 Accessories and consumables</b>	<b>40</b>
14.1 Accessories	40
14.2 Consumables	40
<b>15 Technical data</b>	<b>41</b>

## 1 Declaration of conformity

We declare under our sole responsibility that the product to which this declaration relates is in conformity with directives 2014/35/EU, 2006/42/EC, 2014/30/EU and 2011/65/EU and conforms with the following standards or normative documents: EN 61010-1, EN 61010-2-051 and EN 61326-1.

## 2 Warranty

In accordance with **IKA** warranty conditions, the warranty period is **24** months. For claims under the warranty please contact your local dealer. You may also send the machine direct to our factory, enclosing the delivery invoice and giving reasons for the claim. You will be liable for freight costs.

The warranty does not cover worn out parts, nor does it apply to faults resulting from improper use, insufficient care or maintenance not carried out in accordance with the instructions in this operating manual.

## 3 Warning symbols



Indicates an (extremely) hazardous situation, which, if not avoided, will result in death, serious injury.



Indicates a potentially hazardous situation, which, if not avoided, can result in death, serious injury.



Indicates a potentially hazardous situation, which, if not avoided, can result in injury.

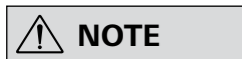

Indicates practices which, if not avoided, can result in equipment damage

## 4 Safety instructions

### General information



**Please read the instruction manual in full before use and follow the safety instructions.**

- Keep the instruction manual in a place where it can be accessed easily.
- Ensure that only trained staff use the device.

- Be sure to comply with all safety instructions, directives and all matters of health, safety and accident prevention in the workplace.
- Wear your personal protective equipment.

### Work with the device



**Oxygen as a compressed gas is oxidising; intensively aids combustion; can react violently with flammable materials.**

Observe the relevant points of danger shown in Fig. 4.

Combustion gases are hazardous to health, therefore the venting hose must be connected to a suitable gas cleaning system or extraction system.

Please observe chapter "15 Technical data".

If you are burning unknown samples, leave the room or keep well away from the calorimeter.

**Do not use oil or grease!**

**The IKA C 6000 global standards/isoperibol calorimeter must not be used for testing explosive samples.**



**Do not use distilled or demineralised water (due to increased danger of corrosion)!**

**The C 6000 must be switched off when you fit peripheral devices.**



**When handling combustion samples, combustion residue and auxiliary materials, please observe the relevant safety regulations. The following materials, for example, could pose a risk:**

- corrosive
- highly flammable
- explosive
- bacteriologically contaminated
- toxic.



**A constant ambient temperature is an important requirement for ensuring the high measuring accuracy of the system. Observe the conditions for the place of installation.**

- The **IKA C 6000** global standards/isoperibol calorimeter system may be used only in conjunction with the decomposition vessels C 6010 or C 6012 (Chapter 15 Technical data).
- Do not operate the device in explosive atmospheres, in the presence of hazardous materials or under water.
- Please observe the relevant regulations when handling oxygen.
- When operating with tap water/from a tap, **IKA** recommends that you use a standard water stop valve in the water supply line.
- At the end of the work period, close the main valve for the oxygen supply.
- Only change the main fuse when you have unplugged the mains power supply.

### Decomposition vessel



**Perform a leakage test on the decomposition vessel before each combustion process (see operating instructions C 6010/6012).**

**Risk of corrosion!**  
Substances with high halogen content must not be combusted in the C 6010 decomposition vessel; instead use the C 6012 decomposition vessel.

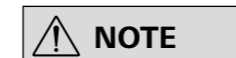

**Observe the operating instructions for the decomposition vessels C 6010/C 6012.**



**When using stainless steel crucibles thoroughly check their condition after each experiment. If the material gets thinner, the crucible may catch fire and damage the decomposition vessel. Crucibles must not be used for more than 25 combustions for safety reasons.**

- Once the pressure test has been performed, a release code can be entered to enable the decomposition vessel to be used for further measurements (see decomposition vessel operating instructions). The warning message will then disappear.
- Please observe the maximum pressure for filling with oxygen (Chapter "15 Technical data"). Check the set pressure on the pressure reducer of your oxygen supply.

- Please observe the maximum energy input in the decomposition vessel (Chapter "15 Technical data").
- Decomposition vessels are experiment autoclaves and must be tested by a technical expert after **every** use.
- Individual use is understood here to include a series of experiments performed under roughly the same conditions in terms of pressure and temperature. Experiment autoclaves must be operated in special chambers.
- The decomposition vessels must undergo repeated tests (internal tests and pressure tests) performed by the technical expert. The frequency of these tests is to be determined by the operator on the basis of experience, type of operation and the material used in the decomposition vessel.

#### Pressure vessel



**Only technical experts may perform pressure tests and maintenance work on the pressure vessel.**

- National directives and laws must be observed for operating pressure vessels!
- Anyone operating a pressure vessel must keep it in a proper condition, operate it properly, supervise it, carry out the necessary maintenance and repair work immediately and implement the safety measures required in the circumstances.
- Pressure vessels must not be used if they have defects which could pose a risk to staff or third parties.

#### Maintenance



**If the maintenance, and especially the pressure testing, is not performed or is performed incorrectly, there is a risk the decomposition vessel may burst or an uncontrolled internal fire may occur at the electrodes which could burn away the seals (oxyacetylene torch effect), thus posing a risk to life and limb.**

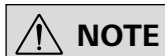

**We recommend that you send the pressure vessel to our factory for inspection, and if necessary, repair after 1000 tests or after one year or sooner depending on use.**

- The declaration of conformity becomes invalid if mechanical modifications are carried out to the experiment autoclaves or if tightness can no longer be guaranteed as a result of major corrosion (e.g. pitting by halogens).
- Perform servicing work only when the equipment is depressurised.

#### Permitted media



**If the burning behaviour of a material is unknown, it must be tested before combustion in the decomposition vessel (risk of explosion).**

**Benzoic acid may only be combusted in its pressed form! Flammable dust and powder must be first pressed. Oven-dry dust and powder such as splints, hay, straw etc. explode when combusted! Always wet these materials first!**



**Highly flammable liquids with a low vapour pressure (e. g. tetramethyl dihydrogen disiloxane) must not directly touch the cotton thread!**



**When burning substances containing metals, ensure that the total energy input is not exceeded.**

- Tubes and screwed joints for oxygen, and all seals on the decomposition vessel must be kept free of grease.
- The condition and function of the seals must be checked and ensured by way of a leakage test.
- In particular the threads on the pressure vessel and the union nut are subject to considerable stress and must therefore be checked regularly for wear.
- To prolong the life of wearing parts (o-rings, seals, etc.) we recommend that you always work with a water trap in the decomposition vessel.
- Contact the **IKA** Maintenance Department to perform the pressure test. Comply with the safety instructions in this respect.
- If the appliance is not going to be in operation for a long period of time, it is advisable to completely empty the calorimeter's water circulation. Likewise, the water must be drained out before transportation.

## 5 Correct use

### 5.1 Use

The **IKA C 6000** global standards/isoperibol calorimeter system is used for calorific value determination of solid and liquid substances. This is done by placing a known quantity of a substance in a decomposition vessel which is surrounded by a water bath.

The calorific value of the sample can then be calculated from the resulting increase in temperature, the sample mass and the known thermal capacity of the overall system.

Intended use: Tabletop device

### 5.2 Area of use

- laboratories                      - schools                      - universities

The device is suitable for use in residential areas and all other areas.

The safety of the user cannot be ensured:

- If the device is used in conjunction with accessories not supplied or recommended by the manufacturer!

- If the device is not used for the intended purpose as specified by the manufacturer.
- If modifications are made to the device or the PCB by third parties.

### 5.3 Recommended method of operation in working mode



**The working mode temperature should always be in the room temperature range (+/- 2 °C) for precise measurements.**

1. Read the operating instructions and get to know the device.
2. Check that your peripheral devices are compatible with the calorimeter (Chapter 11.3 Modules).
3. Select an appropriate place of installation (Chapter 8.1 Place of installation) and commission the calorimeter (Chapter 10 Commissioning).
4. Select a working mode to suit the ambient temperature and your requirements. In dynamic mode in particular, too great a difference between the selected working mode temperature and room temperature has a direct effect on the measuring accuracy of the device. Set the corresponding cooling water temperature (Chapter 15 Technical data).

Room temperature	Cooling temperature	Working mode IKA C 6000 global standard	Working mode C 6000 isoperibol
22 °C	12 °C - 20 °C Operation at water connection 17 °C - 20 °C Operation with condenser	Adiabatic 22 °C Isoperibol 22 °C Dynamic 22 °C	- Isoperibol 22 °C Dynamic 22 °C
25 °C	20 °C - 23 °C	Adiabatic 25 °C Isoperibol 25 °C Dynamic 25 °C	- Isoperibol 25 °C Dynamic 25 °C
30 °C	23 °C - 27 °C	Adiabatic 30 °C Isoperibol 30 °C Dynamic 30 °C	- Isoperibol 30 °C Dynamic 30 °C

#### Working mode: Adiabatic

The calorimetric decomposition vessel is ignited in a vessel filled with water (inner vessel), which in turn is in an insulating cover filled with water (outer vessel). No energy exchange takes place between the inner vessel with decomposition vessel and the outer vessel. For details, please consult the relevant international standards (e.g. DIN 51900-3).

#### Working mode: Isoperibol:

The calorimetric decomposition vessel is ignited in a vessel filled with water (inner vessel), which in turn is in an insulating cover filled with water (outer vessel). A specified energy exchange takes place between the inner vessel with decomposition vessel and the outer vessel. For details, please consult the relevant international standards (e.g. DIN 51900-2).

#### Dynamic working mode:

A quick measuring mode developed by **IKA**. Its procedure and results are not subject to international standards.

5. Register the decomposition vessel during initial commissioning (Chapter 11.2 Decomposition vessel).
6. Switch the device to run hot for approx. 1 hour before starting measurements. To achieve accurate measurements you need a device that is adjusted to its ambient temperature (Chapter 10 Commissioning).
7. Every decomposition vessel that you use must be calibrated in the relevant working mode (adiabatic/isoperibol/dynamic 22 °C; 25 °C; 30 °C) during commissioning. This is done by burning a calibration substance with a known calorific value - generally benzoic acid (Chapter 6.1 Determining the calorific value). For the number of calibrations and evaluation required, see the relevant standards. You can test the stability of the measurements through control calibrations at regular intervals.
8. Select a working mode. If you are working in adiabatic mode, you must carry out an adjustment at the relevant operating temperature (22 °C; 25 °C; 30 °C). Observe the Adjustment instructions (Chapter 6.5 Adjustment). An adjustment allows you to automatically determine correct internal parameters for implementing the adiabatic principle.

With the C 6000 global standard you can now carry out adiabatic, isoperibol and dynamic measurements at specified working temperatures, and with the C 6000 iso you can carry out isoperibol and dynamic measurements at the specified working temperatures. For adaptation to individual laboratory tasks, use original **IKA** consumables and accessories.

## 6 Useful information

The decomposition vessel C 6010/C 6012 is manufactured in accordance with the directive for pressure equipment 2014/68/EU. This is indicated by the CE symbol with the ID number of the notified body. The decomposition vessel is a category III pressure device. The decomposition vessel was subjected to an EC prototype test. The declaration of conformity confirms that this decomposition vessel corresponds to the pressure device described in the EC prototype test certificate. The decomposition vessel has undergone a pressure test with the test pressure of

33 MPa and a leakage test with oxygen at 3 MPa. Some materials tend to explode when combusted (e.g. due to formation of peroxide), which can cause the decomposition vessel to crack. Furthermore, toxic combustion residue in the form of gases, ashes or condensation, for example, is possible in the inner wall of the decomposition vessel.

You can obtain a copy of the Directive for pressure equipment 2014/68/EU from Beuth Verlag.

### 6.1 Determining the calorific value

The specific calorific value of the sample is calculated from:

- Weight of fuel sample
- Thermal capacity of the calorimeter system (C-value)
- Temperature increase of water in the calorimeter system

For complete combustion the decomposition vessel of the calorimeter system is filled with pure oxygen (quality 3.5). The pressure of the oxygen atmosphere in the decomposition vessel should be set to 30 bar (max. possible is 40 bar). To precisely determine the calorific value of a material the combustion needs to take place under specifically defined conditions. The relevant standards are based on the following assumptions:

- The temperature of the fuel before combustion depends on the set start temperature between 20 °C and 30 °C.
- The water contained in the fuel before combustion and the water formed whilst combusting the hydrogenous compounds of the fuel is in fluid form after combustion.
- Oxidation of the air nitrogen has not take place. The gaseous products after combustion include oxygen, nitrogen, carbon dioxide, sulphur dioxide and the oxidation products of the sample.
- Solid materials may form (e.g. ashes).

In many cases, however, not just the combustion products referred to in the standards are produced. In such cases the fuel sample and the combustion products must be analysed, providing data for revised calculations.

The standard calorific value is then calculated from the measured calorific value and the analysis data.

The calorific value  $H_o$  is calculated from the quotient of the quantity of heat released during complete combustion of a solid or liquid fuel and the weight of the fuel sample. The aqueous compounds of the fuel must be present after combustion in liquid form.

The formula for the calorific value is:

$$H_o = (CV \cdot dt - Q_{ext}) / m$$

$H_o$  Calorific value

$m$  Mass of the sample

$dt$  Measured and corrected increase in temperature

$Q_{ext}$  All external energy originating from the ignition wire, the ignition aids, the combustion aids and the formation of acids

$CV$  C value (thermal capacity) of the calorimeter

The heat value  $H_u$  is the same as the calorific value, minus the condensation energy of the water contained in the fuel and formed through combustion.

The heat value is the more important parameter from a technical point of view because in all major, technical applications only the heat value can be evaluated in terms of energy.

The bases of calculation for the calorific and heat value can be found in the relevant standards (e. g.: DIN 51 900; ASTM D 240; ISO 1928).

### 6.2 Corrections

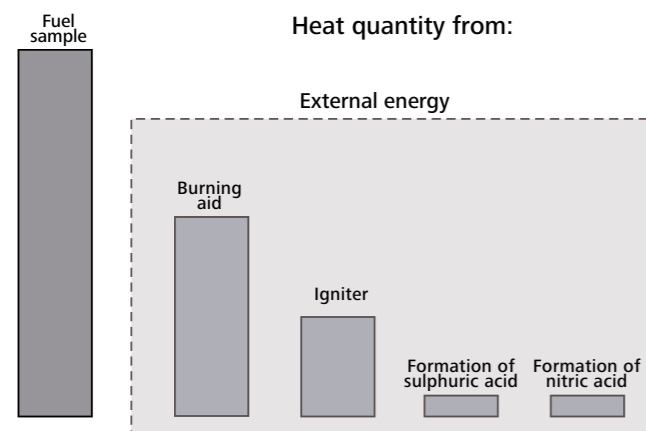

Due to the nature of the system a combustion test does not just produce the combustion heat of the sample, but also heat from external energy.

This can fluctuate considerably in relation to the heat quantity of the fuel sample.

The combustion heat of the cotton thread which ignites the sample and the electric ignition energy would distort the measurement. This influence is taken into account in the calculation by way of a correction value.

Materials which are difficult to ignite or combust are combusted together with a burning aid. The burning aid is weighed and put

into the crucible with the sample. The additional heat quantity can be determined from the weight of the burning aid and its known specific calorific value. You must correct the test result by this heat quantity.

#### 6.2.1 Acid correction

Virtually all of the materials to be studied contain sulphur and nitrogen. Under the conditions in calorimetric measurements, sulphur and nitrogen combust to  $SO_2$ ,  $SO_3$  and  $NO_x$ . Together with the water from combustion and moisture, sulphuric and nitric acid as well as heat of solution are produced. In order to obtain the standard calorific value, the influence of the heat of solution on the calorific value is corrected.

To achieve a specified end state and to record all acids quantitatively, distilled water or another appropriate absorbing liquid is placed in the decomposition vessel in advance before the experiment

in accordance with the applicable standards. The combustion gases form acids with this absorption liquid and the combustion water. The calibration of the system must have been performed in accordance with the instructions!

After the combustion the decomposition vessel is thoroughly flushed with distilled water to collect the condensate that has been deposited in the inner wall of the vessel as well. The solution produced in this way can now be examined with appropriate peripheral devices to detect its acid content. For more detailed information contact **IKA** or an authorised dealer.

### 6.3 Note on the sample



**DANGER**

**If you are burning unknown samples, leave the room or keep well away from the calorimeter.**



**WARNING**

**Risk of corrosion! Substances with high halogen content must not be combusted in the C 6010 decomposition vessel; instead use the C 6012 decomposition vessel.**

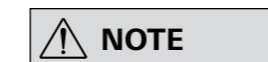

**NOTE**

**To prolong the life of wearing parts (o-rings, seals, etc.) we recommend that you always work with a water trap.**

- Most fluid substances can weighed out directly into the crucible. Liquids that are cloudy or that have water that may separate must be dried or homogenised before being weighed out. The water content of these samples must be determined.

- Highly volatile substances are poured into combustion capsules (gelatine capsules or acetobutyrate capsules, see Accessories) and combusted together with the capsules.

- For substances that are difficult to ignite or low in calories, use the burning aid (see accessories). Before filling the capsule or the combustion bag with the substance to be determined, weigh them to calculate the extra external energy added by the burning aid from the weight and the calorific value. This must be taken into account in  $Q_{Extern2}$ . You should keep the amount of burning aid used to a minimum.

The **IKA C 6000** global standards/isoperibol calorimeter system is a high-precision measuring instrument used for routinely determining the calorific value of solid and liquid substances. However exact measurements are only possible when the individual test steps are carried out carefully. For this reason the procedure must be followed precisely.

A few points should be noted in respect of the substances to be combusted:

- Normally solid combustion substances in powder form can be combusted directly. Materials which combust quickly (e.g. benzoic acid) must not be burnt loose. Benzoic acid may only be combusted in its pressed form! Flammable dust and powder must be first pressed. Oven-dry dust and powder such as splints, hay, straw etc. explode when combusted! Always wet these materials first! Highly flammable liquids with a low vapour pressure (e.g. tetramethyl dihydrogen disiloxane) must not directly touch the cotton thread!
- Highly flammable substances tend to spray. Such substances must be pressed into tablets before combustion. The **IKA** pelleting press C 21, for example, is suitable for this task.

## 6.4 Complete combustion



**If there is any unburnt residue, the test must be repeated.**

It is essential that the sample fully combusts to ensure correct determination of the calorific value. After each experiment check the crucible and all the solid residue for signs of incomplete combustion.

Complete combustion is not guaranteed for materials with a tendency to spray.

## 6.5 Adjustment (only IKA C 6000 global standards)



**If the device is to be operated in adiabatic function, prior adjustment in the respective temperature range (22 °C, 25 °C or 30 °C) is necessary.**

Adjustment must be performed in the following cases:

- When first commissioning the calorimeter and when its place of installation has been changed.
- If the measuring times for adiabatic measurements are regularly in excess of 15-20 minutes.
- If adiabatic measurements are frequently aborted because the time limits for the pre-trial or main trial have been exceeded.

Procedure for adjustment:

- In the menu select "Settings, Measurement settings, Adiabatic working mode".
- The adjustment starting temperature is preset by selecting the working mode/temperature range.
- Start the adjustment by selecting the selection field r (e.g. Adjustment 25 °C). Insert the decomposition vessel (without sample).

Materials which are difficult to ignite (materials with a high mineral content, low caloric materials) can often only be fully combusted using burning aids such as combustible crucibles, combustible capsules or combustible bags (Chapter 14.2 consumables). It is also possible to use liquid burning aids such as paraffin oil. The ignition aids (e.g. cotton thread) must also burn completely.

- Follow the instructions.
- Adjustment starts automatically and is completed within approx. 1 hour. After the adjustment has been successfully completed the adjustment value appears as an increase in temperature in the measurement record for the measurement that was performed and is automatically adopted as a system parameter.
- You can see the adjustment value under the menu item "Information adjustment".

After successful completion of adjustment the device automatically changes the mode of operation to the corresponding adiabatic mode.

Adjustment 22 ⇔ Adiabatic 22 ⇔  
Adjustment 25 ⇔ Adiabatic 25 ⇔  
Adjustment 30 ⇔ Adiabatic 30 ⇔



## 6.6 Calibration



**Regular calibration is vital to maintaining measurement accuracy.**

To guarantee accurate and reproducible measurement results, the calorimeter system is calibrated after initial start-up, after maintenance work, after parts are replaced and at specified time intervals. During calibration the thermal capacity of the calorimeter system is revised.

To this end, a specified quantity of a reference substance is burned in the IKA C 6000 global standards/isoperibol under test conditions. As the calorific value of the reference substance is known, after it has been burnt it is possible to calculate the thermal capacity on the basis of the temperature increase of the calorimeter system. The reference substance for calorimetry at an international level is benzoic acid, as per the National Bureau of Standards (NBS-Standard Sample 39 J) with guaranteed calorific value.

The thermal capacity is derived from the formula for the calorific value (Chapter 6.1 Determining the calorific value):

$$CV = (H_o * m + Q_{ext}) / dt$$

Depending on the standard used, determination of the thermal capacity may require performance of several measurements.

Using various statistical criteria the average value is calculated and is used as the thermal capacity for subsequent determinations of calorific values.

For more detailed information on calibration, please see the relevant standards. If the IKA C 6000 global standards/isoperibol is operated with several decomposition vessels, you will need to determine the heat capacity of the system for each decomposition vessel. The parts of the decomposition vessel must not be replaced. In addition the thermal capacity depends to a small extent on the measurement procedure used. The thermal capacity must be determined for each measurement procedure that is used.

### Note on calibrations

The calibration must be carried out under the same conditions as the subsequent tests. If substances are used in combustion tests (e.g. distilled water or solutions), you must use exactly the same amount of this substance for calibration.

For determination of calorific values the increase in temperature must be about as great as for the calibration (e.g. g.: 2 tablets = approx. 1 g benzoic acid = 3 K). The optimum sample quantity must be determined by several trials where necessary.

## 6.7 System properties



**Operation is only permitted with decomposition vessels C 6010 and C 6012.**

The system has the following properties:

- Reduction of routine tasks thanks to automated measuring procedure
- Integral oxygen filling/degassing
- Automatic vessel detection
- Operation without cooling unit: Connects to tap with pressure reducer IKA C 25; temperature range 12 °C - 20 °C; water consumption per measurement approx. 4 L; max. pressure 1 bar to 1.5 bar (Chapter 15 Technical data).

- Operation with active cooling unit e.g. IKA RC 2 (Chapter 5.3. Recommended method of operation in working mode)
- Measurement and determining of calorific value and calculation of the heat value as per DIN (Chapter 15 Technical data).
- Measuring range: max. 40,000 J (This corresponds to an increase in temperature in the decomposition vessel of approx. 5 K).
- Operation possible with IKA PC-Software CalWin® C 6040
- Can be connected to sample rack C 5020
- Includes printer connection (USB, network, RS 232 (Fig. 2, 6))
- USB drive connection (Fig. 1, 4a)

# 7 Transport und Unpacking

## 7.1 Transport



**The appliance must be completely emptied before storing and transportation.**

The system must be protected against mechanical impact, vibrations, dust deposits and corrosive ambient air during transportation and storage. It is also important to ensure that the relative humidity does not exceed 80 %.

## 7.2 Unpacking

- Unpack the device carefully.
- Any damage should be notified immediately to the shipping agent (post office, railway network or transport company).

## 7.3 Scope of delivery

- Calorimeter IKA C 6000 global standards/isoperibol
- Attachment set

Tool	
C 60.1012 Organizer	
C 6000.1 water protect	
C 723 Benzoic acid	
Double-end/single-end spanner	
Sealing disc	
Filter spanner	
Screwdriver	

- Power supply cable
- USB drive
- Operating instructions
- Warranty card

Hoses:	
Emptying aid	
Discharge hose 1.5 m (EMPTY)	
Water inflow pipe (IN):	
Water return pipe (OUT):	
Venting hose (OUT)	
Connecting pipe O <sub>2</sub> (IN)	

## 8 Setting up and assembly

### 8.1 Place of installation



#### NOTE

A constant ambient temperature is an important requirement for ensuring the high measuring accuracy of the system. Observe the conditions for the place of installation.

- No direct solar radiation
- No draughts (e.g. beside windows, doors, air conditioning)
- Sufficient distance from radiators and other heat sources
- the minimum distance between the wall and the back of the device must not be less than 25 cm.
- Laboratory additions such as shelves, cable ducts, ring lines etc. must not be build above the system.
- The room temperature must remain constant.
- The system must be installed on a level surface.

For operation of the system the following must be available at the place of installation:

- A power supply corresponding to the type plates of the system components,
- An oxygen supply (99.95 % pure oxygen, quality 3.5; pressure 3 MPa) with pressure gauge.

There must be a shut-off device for the oxygen supply. Observe the instructions for oxygen (Chapter 4 Safety instructions).

### 8.2 Assembly of the attachments

#### 8.2.1 Recirculation chiller/thermostat



#### CAUTION

Do not use distilled or demineralised water (due to increased danger of corrosion)!

In normal operation the discharge hose at the "EMPTY" connection (Fig. 2, 12) must not be inserted.

Make sure the filter casing is always securely closed.



#### NOTE

Observe the operating instructions for the condenser/thermostat.

It is recommended mixing 5 l tap water (drinking quality) with 25 ml of water bath additive C 6000.1, as this improves the usable life of the water.

IKA recommends that you use the system with the recirculating condenser RC 2 at a speed of 2800 1/min (place of installation downstream of the C 6000: 3200 1/min).

1. Insert the inflow pipe into the "IN" port until it clicks home in the "IN" inlet (Fig. 2, 10).
2. Connect the other end of the pipe to the "OUT" port of the condenser (water pressure max 1.5 bar). Insert the return pipe into the "OUT" port until it clicks home (Fig. 2, 11) and connect the other end of the pipe to the "IN" port of the condenser. The "EMPTY" connection is intended only for emptying the device, e.g. for transport purposes (Chapter 12.1.3 Emptying water).



#### 8.2.2 Water supply line



#### CAUTION

Operation is only permitted with the pressure reducer IKA C 25.

Observe the operating instructions for the IKA C 25.



#### NOTE

Follow the instructions in Chapter "11.3 Modules".

The pressure control valve IKA C 25 must be on the tap for the calorimeter to be operated and it is preset to a output pressure of approx. 1.5 bar.

The valve is fitted in the line to the water connection.

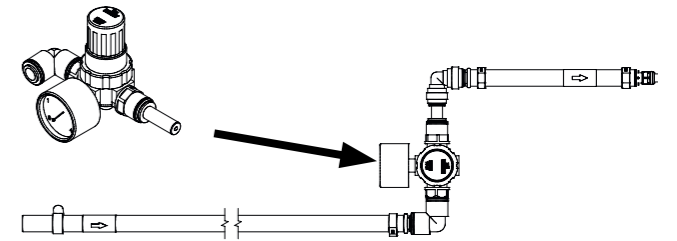

#### 8.2.3 Oxygen supply



#### NOTE

The O<sub>2</sub> connection tube can be removed only after it has been depressurised. Therefore use the tool (scope of delivery).

1. Insert the O<sub>2</sub> connection tube into the calorimeter "IN" port until it clicks home.
2. Connect the free end to the pressure reducer IKA C 29. Push through the 2 points where there is palpable resistance. Removal entails the same operations performed in reverse order.

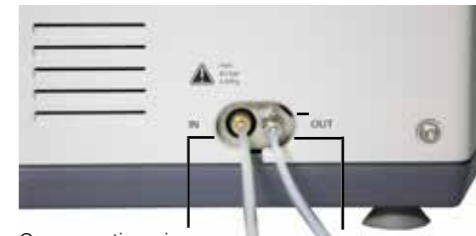

O<sub>2</sub> connection pipe  
IN max. 40 bar

Venting hose

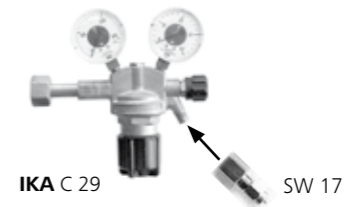

IKA C 29

SW 17

#### 8.2.4 Venting hose



#### DANGER

Combustion gases are hazardous to health, therefore the venting hose must be connected to a suitable gas cleaning system or extraction system.

The venting hose discharges the combustion gases from the decomposition vessel after every combustion trial. When laying the venting hose ensure that it is not crushed or kinked. Screw the venting hose to the screw coupling SW 8 (Chapter 8.2.3 Oxygen supply) on the calorimeter and position the free end under the extractor hood or connect it to a gas washing device. Comply with the applicable safety regulations in this respect.

#### 8.2.5 Mains power supply

Check that the available mains power supply matches the mains power supply particulars listed on the rating plate.

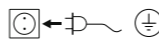
 If these conditions are met, the device is ready for operation when it is plugged in to the mains.

Observe the ambient conditions indicated in Chapter "15 Technical data".





### 8.2.6 Peripheral devices



#### WARNING

The peripheral devices and the calorimeter must be switched off when they are connected.

PC RS232	Baud rate: 9600 Data bits: 8 Stop bits: 1 Parity: none Handshake: none
Balance RS232	Serial connection for a balance interface (Mettler, Ohaus, Sartorius, Kern). <i>For further information, see Chapter "11.3.1 Balance".</i>
Standard setting	Baud rate: 1200 Data bits: 7 Parity: odd Stop bits: 1 Handshake: none
Ethernet	Network connection for data transfer via the network, e.g. to a network printer.
USB device	USB interface (only for maintenance)
USB host	Interface for connecting a USB mouse.
Sample rack	Interface for connecting the C 5020 sample rack



### 8.2.7 Mains switch:



#### CAUTION

Data may be lost if the appliance is switched off other than by following the menu commands.

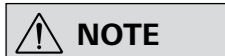

#### NOTE

The device is switched on and off using the mains switch (Fig. 1, 5).

Switch the device off at the on/off switch.

→ Lift goes up.

Switch the appliance off only by using the menu commands

→ Lift goes down.

Switch the device off at the mains switch only when directed to do so by the menu command.

## 9 Operator panel and display

- The menu option selected has a blue background in the display.
- When using a keyboard the input field has a yellow background.
- Inactive symbols have a grey background.

### 9.1 Explanation of the display

Symbol	Function
	Back to the last menu item
	Edit menu
	Create: Decomposition vessel or measurement
	Start a measurement (the device is in Wait mode)
	Confirm inputs
	Save data
	Shutdown: This saves the measurements, the cover of the calorimeter is closed and the software is shut down. After this, switch off the calorimeter and all the accessories.
	Drop-Down menu for further selection options
	Open the password-protected maintenance area

	Change the working mode (Different working modes are displayed depending on the water temperature.)
	System test restart.
	Request a balance value
	Open submenu
	Reset sample rack Update printer
	Maintenance menu
	Print
	Measurement detail view
	Graph view
	Measurement created but not yet performed
	Skip Initial System Test

### 9.2 Status symbols

#### Measurement:

Symbol	Status
	Calibration/simulated calibration
	Measurement/simulated measurement
	Sample rack measurement and calibration
	Measurement successfully completed but not yet evaluated
	Cancellation before ignition, calibration can be started again
	Cancellation after ignition, calibration can no longer be started again
	Cancellation before ignition, measurement can be started again
	Cancellation after ignition, measurement can no longer be started again
	Measurement/system test running

#### Device status:

Symbol	Status
	Standby mode
	Ignition/main trial
	Cancellation of measurement/calibration
	<u>Animation:</u> Device opening/closing
	<u>Animation:</u> Filling/Emptying
	<u>Animation:</u> Decomposition vessel being scanned (RFID active)
	<u>Animation:</u> Phases of the temperature compensation (during pre-trial and main trial)

# 10 Commissioning

## 10.1 Switching on

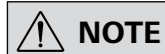

**NOTE**

After the IKA C 6000 global standards/isoperibol calorimeter has been switched on, the display is active and can be operated using a stylus or finger.



The cover opens automatically. While the software is loading, the information screen is displayed for about 30 seconds.

## 10.2 System test

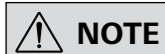

**NOTE**

During initial system start (ca. 5 minutes) a global standard device is preset to Adiabatic (22 °C) and an isoperibol device is preset to Isoperibol (22 °C).

The system test is performed automatically every time the IKA C 6000 global standards/isoperibol is switched on.



During the system test the "Initial System Test" display is displayed. The cooling water temperature, flow rate, temperatures etc. are tested.



Colour	Function
red	Cooling water temperature is outside permitted limits.
yellow	Selected method of operation not possible --> Modification required
green	Successful test

In parallel to the system test, safety instructions are displayed and they must be confirmed.

After a successful system test the device goes to the main menu and measurements can be run.

## 10.3 Switching off

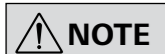

**NOTE**

The device must be in Wait mode for it to be switched off.

Observe the procedure, in order to avoid data loss.

Procedure:

1. The device is in wait mode.
2. Carry out shutdown
3. Press the mains switch.



## 10.4 Menu structure

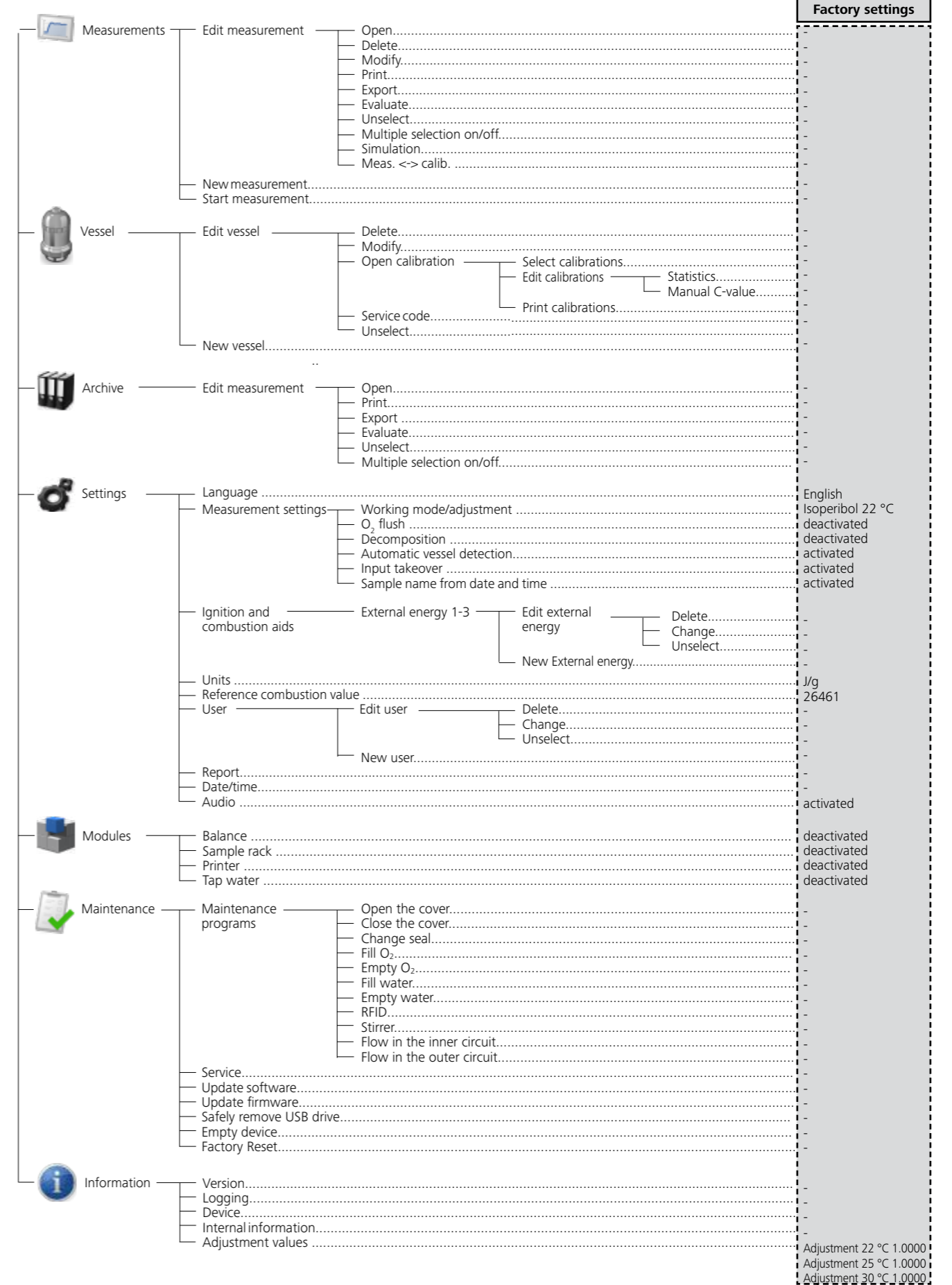

## 10.5 Menu details, main menu



### NOTE

You can reach individual menu items by moving horizontally.

#### Progress bar (Item A)

Press on the progress bar to display the data about the current measurement or data about the last measurement (Chapter 11.6.3 Opening a completed measurement).

Item C	Item D	Explanation
	Measurements	Display and manage current measurements and calibrations.
	Vessel	Create, display and manage decomposition vessels.
	Archive	Manage archived measurements.
	Settings	Settings für Measurements (Chapter 11 Operation, 11.4 Settings)
	Modules	Settings for peripheral devices.
	Maintenance	Maintenance programs
	Information	Device information on firmware, software, device type and version.

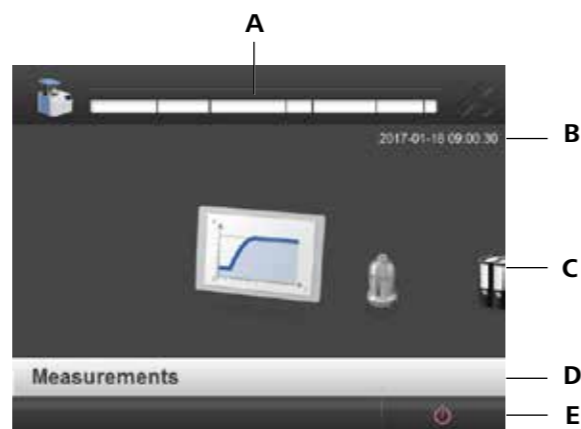

#### Item Function

A	Progress bar
B	Current Date and time
C	Main menu elements
D	Name of the selected menu
E	Function bar

#### Function bar (E)

Shows the display functions (Chapter 8.1 Explanation of the display).

## 10.6 Touch screen input field



### NOTE

The keyboard adapts to the relevant input field automatically (alphanumeric or numerical).

For manual input, press an input field.



## 11 Operation

### 11.1 Procedure



### NOTE

Follow the operating instructions for the decomposition vessel C 6010/C 6012.

The menu item "Measurements" refers to both calibration of the calorimeter system and the actual measurements for determining the calorific value. The following preparations must be performed in order to prepare the system to take a measurement:

1. Weigh out the substance directly into the crucible with an accuracy of 0.1 mg. It may be necessary to put some distilled water or a solution into the decomposition vessel. The maximum acceptable weight of the sample that is added is restricted, and it may weigh from 0.001 g to 5 g.
2. To prolong the life of wearing parts (o-rings, seals, etc.) we recommend that you always work with a water trap.

3. As a rule the weighted sample must be selected in such a way that the temperature increase during the measurement is below 5 K and comes close to the temperature increase of the calibration (max. extra energy: 40000 J) Failure to observe these instructions could result in damage to the calorimeter. If the maximum energy input is exceeded, we recommend that the calorimeter is sent back for repair (Chapter 12.1. Cleaning the system).

When working with unknown substances, select very small weighted samples (approx. 0.25 g) at the start in order to determine the natural energy. If you are burning unknown samples, leave the room or keep your distance from the calorimeter. If substances such as distilled water or solutions are added to the decomposition vessel for combustion tests, you must use exactly the same amount of those substances during calibration.

### 11.2 Decomposition vessel

#### 11.2.1 Creating a decomposition vessel

A decomposition vessel has to be registered in the system to carry out measurements.

1. Go to the "Decomposition vessel" menu.
2. Select to create a new decomposition vessel.
3. Enter:
  - Name of the decomposition vessel (max. 30 characters)
  - Serial number of the decomposition vessel (exactly 10 characters)
  - Number of previous ignitions with this decomposition vessel
  - Check if platinum wire is used by decomposition vessel

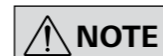

### NOTE

A pressure test must be performed after a decomposition vessel has reached or exceeded the recommended number of ignition cycles. You can continue to work with the decomposition vessel after you have confirmed a warning.

4. Scan the decomposition device in the devices RFID sensor field (Chapter 11.5.4 Starting a measurement).
5. When you have filled out all the obligatory fields, confirm what you have entered.



#### 11.2.2 Editing a decomposition vessel

You can edit decomposition vessels later once they have been created.

1. Select a created decomposition vessel from the list, press and select as appropriate:
  - Delete
  - Modify
  - Open calibration: Managing calibrations of the selected working mode (see the following chapter on calibration).
  - Service Code: If a print test was carried out the warning can be deactivated using the service code.
  - Unselect
2. The relevant input form opens.



### 11.2.3 Calibration

The decomposition vessel must be calibrated to carry out a measurement. The C-value of the decomposition vessel can be determined using calibrations.

1. Go to the "Decomposition vessel" menu.
2. To edit, select a decomposition vessel from the list and press .
3. Select "Open calibration".
4. Select a calibration that you want to include in the C-value.
5. Save the inputs.

**NOTE** When the C-value is updated the calibration date is renewed.

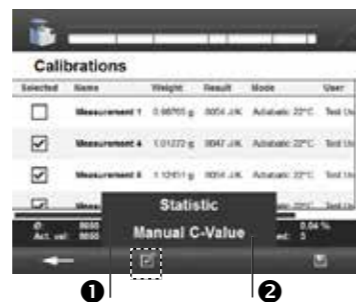

#### 1 Statistics

The statistic evaluates the selected calibrations. Displayed values: Selected values, average ( $\bar{x}$ ), max. value, min. value, range (Max-Min), relative standard deviation (RSD), sigma ( $\sigma$ ) and warning and control limits. The LWL and UWL (lower and upper warning limits) define the range within which 95 % of the calibration measurements should lie.

The LCL and UCL (lower and upper control limits) define the area within which 99.7 % of the calibration measurements must lie for the statistical control to be fulfilled. Calculation of the limits, where sigma = standard deviation,  $\sqrt{}$  = square root and N = number of measurements:

- UCL – average + 3 x sigma /  $\sqrt{N}$
- UWL – average + 2 x sigma /  $\sqrt{N}$
- LWL – average - 2 x sigma /  $\sqrt{N}$
- LCL – average - 3 x sigma /  $\sqrt{N}$

#### 2 Entering manual C-value

You can set the C-value for the decomposition vessel manually here (see previous chapter on calibration).

1. Enter a C-value.
2. Save the input.



### 11.3 Modules (peripheral devices)

**CAUTION** The C 6000 must be switched off when you connect peripheral devices.

**NOTE** Observe the operating instructions for the peripheral devices.

Check the box to directly activate the interface and load external data. Select the submenu to reach its settings.



Menu	Function
Balance	activated/deactivated
Sample rack	activated/deactivated
Printer	activated/deactivated
Tap water	<b>NOTE</b> The function must be activated if the calorimeter is operated while directly connected to a mains water supply. This adapts the system test.



### 11.3.1 Balance

**NOTE** Please take the precise settings (baud rate, data bits etc.) from the operating instructions of the balance you are using.

1. Go to the "Modules" menu.
2. Select the "Balance".
3. Save the input.

This means the standard settings are adopted.

#### Changing standard settings:

1. Go to the "Modules" menu.
2. Select the "Balance".
3. Select the "Submenu" symbol .
4. Enter all the necessary balance values.
5. Request the balance value by pressing . The value appears in the input field.
6. Checking the box for "Use balance" activates the balance and the balance value is used for further functions.
7. Save the input.



#### Working with the scale

**NOTE** Before the transfer, create a new measurement with an external energy.

Before each weighing and transfer of values from the balance, the "TARE" key needs to be pressed.

If a balance is connected to the IKA C 6000 global standards/isoperibol calorimeter, the weighted sample can be sent directly from the balance to the IKA C 6000 global standards/isoperibol calorimeter.

There are two possibilities:

- a) Press the "Print" button on the balance:
- b) Open the "New measurement" input form .

#### Option a):

After pressing the print button on the balance, the currently displayed maximum sample weight value is sent to the calorimeter. The "New measurement" menu opens and the value is entered automatically in the appropriate place (maximum sample weight, external energy). **Attention:** External energy has to be selected first.

The external energy values are calculated automatically based on the specified sample weight and Reference combustion value entered for the aid.

#### Option b):

Request a balance value by selecting the symbol  in the "New measurement" window (Chapter 11.5.1 Creating a measurement).

In the balance settings you can select the transfer order:

- Sample
  - Weight in external energy
- or
- Weight in external energy
  - Sample

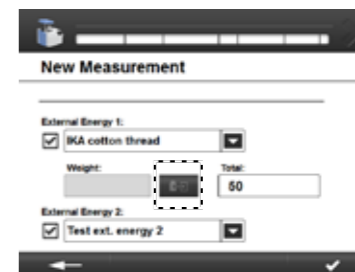

### 11.3.2 Sample rack



**Changing the assignment of the sample rack whilst the IKA C 6000 global standards/isoperibol calorimeter is switched off is not permitted!**

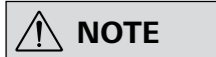

**You can prepare and run as you wish a maximum of 12 measurements in the sample rack.**

The sample rack is used to reliably record and manage individual fuel samples and larger sample sets of up to 12 crucibles. To work with the sample rack you must first check that it is connected to the calorimeter.

#### Installation:

1. Connect the sample rack to the C 6000.
2. Select the sample rack in the menu.
3. Save the input.

#### Working with the sample rack:



**Please note the measurement preparations for the balance (Chapter 11.4.1 Measurement settings).**

1. Create a measurement (11.5.1 Creating a measurement). **Before you save your inputs** place the prepared crucible with which you want to carry out the measurement into an empty compartment of the sample rack. The rack position appears in the input form (top right).
2. Remove the prepared crucible from the sample rack to carry out the measurement. The input form for "Rack position x" opens. The C 6000 detects the crucible and the created measurement data.
3. If no ignition aid/combustion aid has been entered, these can be added.
4. Select a decomposition vessel.
5. Start the measurement.

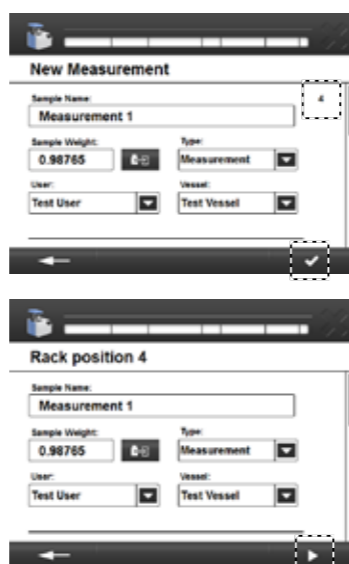

#### Sample rack assignment



**If the sample rack assignment does not correspond to the created measurement, the sample rack must be reset or deactivated. In case of a reset the measurements created for the sample rack are automatically deleted.**

**When the IKA C 6000 global standards/isoperibol calorimeter is restarted the last rack assignment is saved.**

The "Sample rack" tab allows you to check the current assignment.

View	Function
	The C 5020 sample rack is not connected or active.
	The sample rack is connected. All compartments are free.
	The sample rack is connected. <ul style="list-style-type: none"> <li>• Green = free</li> <li>• Red = occupied</li> </ul>

### 11.3.3 Printer

#### Setting the printer



**Please observe the printer operating instructions.**

When a printer is added a name is automatically generated and the connection is taken from the list.

1. Go to the "Printer" menu.
2. Select the "Submenu" symbol.
3. Select a printer from the drop-down list or add a new one using
4. Save the input.

#### Adding a printer

1. Select a printer or a printer protocol from the printer list displayed.

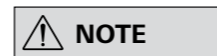

**If a printer is not shown in the list, it can be added using a printer protocol and the IP address. The supported printer protocols for the C6000 are Internet Printing Protocol (ipp, http), AppSocket/HP JetDirect (socket) and LPD/LPR Host or Printer (lpd).**

When a printer protocol is selected you must enter a name yourself. The connection must also be completed.

2. Select the driver.
  - Filter by manufacturer.
  - Select the driver and save the input.

If no printer driver is found for your printer:

- Use the generic printer driver (manufacturer "Generic")
- Use the PostScript Printer Description (PPD) file from the manufacturer. Save the PPD file on the USB drive and insert it into the device (Fig. 1, 4a). Press "Add printer driver from USB drive" and select the PPD file.

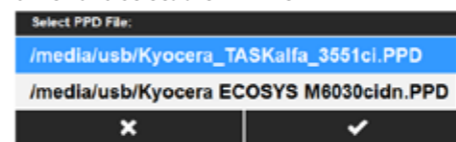

3. Save the inputs.

#### Serial printer



**Other print operations are not possible with this. We recommend the IKA C 1.50 printer with serial settings 9600-8-N-1.**

A serial printer can be connected to PC port of the C 6000. This printer prints the sequential record of the measurements.

- Short protocol: Prints the measurement data (name, sample weight...) and measurement values (temperature difference, ignition energy...)
- Long protocol: also prints measured temperature values.

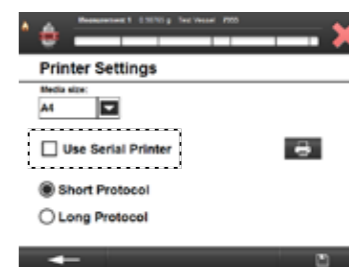
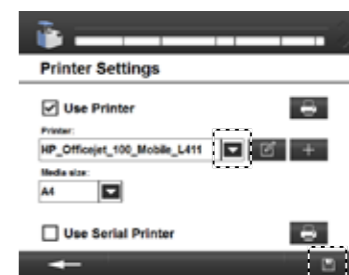

## 11.4 Settings

Menu	Function in the submenu
Language	Set language to be used
Measurement settings	Measurement and procedure settings
Ignition and combustion aids	Manage ignition and combustion aids
Units	Set unit to be used
Reference combustion value	Set reference combustion value
User	Manage user
Report	Set Report to be used
Date/time	Set date and time
Audio	Set audio replay

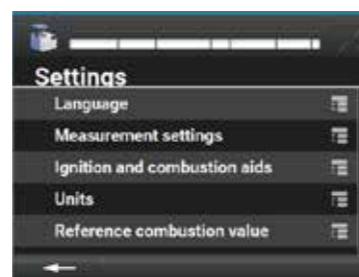

### 11.4.1 Setting the language

1. Go to the menu "Settings, Language".
2. Select a language.
3. Save the input.



### 11.4.2 Measurement settings

1. Go to the menu "Settings, Measurement settings".
2. Select a setting.
3. Save the inputs.

Menu	Function
Working mode	Select a working mode: Isoperibol, Adiabatic, Dynamic and start an adjustment (Chapter 6.5 Adjustment).
O <sub>2</sub> flush	Activate/deactivate oxygen flush before a trial. This means that the decomposition vessel is briefly filled with oxygen then emptied twice before it is actually filled, to remove air nitrogen.
Decomposition	Activate/deactivate venting of the decomposition vessel after the trial. A subsequent analysis of the combustion residues can be carried out.
Automatic vessel detection	Activate/deactivate detection of the decomposition vessel using RFID.
Input takeover	Activate/deactivate the most recently selected settings. These are adopted when you create a new measurement (external energies, user, decomposition vessel).
Sample name from date and time	Activate/deactivate automatic name generation using the current date (YYMMDDHHmmss).

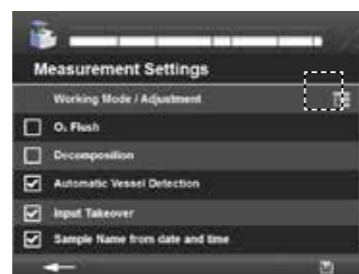

### Working mode

You can select the working mode of the device here.

The C 6000 isoperibol only offers the working modes "Isoperibol and Dynamic". When the working mode is changed, the device carries out a system test to check if the cooling water is in the appropriate range, for example.

For further information on the working modes see Chapter "5 Intended use". An adjustment can also be started here (Chapter 6.5 Adjustment).



### 11.4.3 Creating ignition and combustion aids

You can create several ignition and combustion aids distributed across 3 lists "External energies 1/2/3". When creating a new measurement you can them in the drop-down list (Chapter 11.5.1 Creating a measurement).

1. Go to the menu "Settings, Ignition and combustion aids".
  2. Select an external "External energies" list.
  3. Press **+** to create a new ignition and combustion aid. The default factory setting "IKA cotton wool thread" is preset as standard with 50 J and cannot be edited or deleted.
  4. Enter a unique name (max. 30 characters).
  5. Select a specific or absolute energy value.
  6. Save the inputs.
- Your new ignition and combustion aid appears in the table.

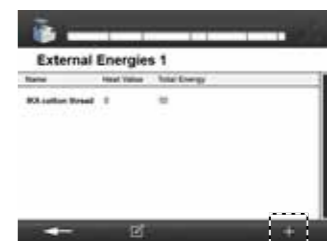

### Editing ignition and combustion aids

Select a created ignition and combustion aid from the list, press **☰** and select as appropriate:

- Delete
- Modify
- Unselect



### 11.4.4 Selecting the unit

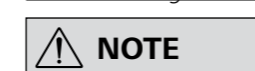

**NOTE**

**When you select a unit all existing display values are converted accordingly.**

1. Go to the menu "Settings, Units".
2. Select a unit.
3. Save the input.

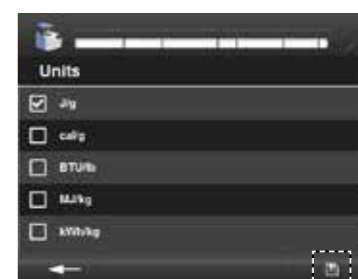

#### 11.4.5 Selecting the Reference combustion value



### NOTE

You can find the current reference combustion value printed on the benzoic acid tablet package. This reference combustion value can be changed.

1. Go to the menu "Settings, Reference combustion value".
2. Enter the desired reference combustion value.
3. Save the input.

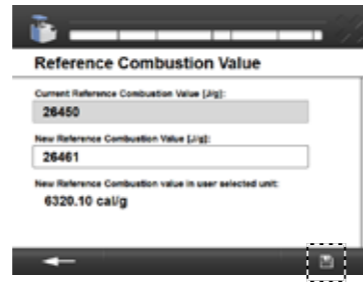

#### 11.4.6 Creating users



### NOTE

Users can be created and administered. Users that have been created can be selected from a drop-down list when a new measurement is created (Chapter 11.5.1 Creating a measurement).

1. Go to the menu "Settings, User overview".
2. Press **+** to create a new user.
3. Enter a unique name (max. 30 characters).
4. Enter an abbreviation for the user name, which will be displayed later when a measurement is created.
5. Save the inputs.



#### Editing a user

Select a created user from the list, press **⌘** and select as appropriate:

- Delete
- Modify
- Unselect



#### 11.4.7 Report

Standard selection options for calculating the heat value.

1. Go to the menu "Settings, Report".
2. Select an Report.
3. Save the input.



### NOTE

Previously evaluated measurements are not updated when a different standard is selected. The measurement must be carried out again.



#### 11.4.8 Setting the date and time

1. Go to the menu "Settings, Date/time".
2. As soon as you select a field, the relevant input field opens. Enter the values.
3. Save the input.



#### 11.4.9 Audio settings



### NOTE

The notification sound before ignition cannot be deactivated.

1. Go to the menu "Audio settings".
2. Select:
  - activate key tones
  - change the system volume ("+" louder, "-" quieter)
  - **▶** (test current volume setting)
3. Save the inputs.



### 11.5 Carrying out a measurement

#### 11.5.1 Creating a measurement

1. Go to the "Measurement" menu.
2. Press **+** to create a new measurement.
3. Enter the name of the measurement - input options:
  - User-defined
  - By date: YYMMDDHHMMSS
  - Automatic: Based on the most recently entered pattern (Measurement\_1 becomes Measurement\_2,...3,...4)
4. Enter the sample weight manually or request the value from the external balance by pressing **⌘**.
5. Select measurement or calibration from the drop-down list.
6. Select from the drop-down list:
  - the decomposition vessel used or "Automatic vessel detection" (Chapter 11.4.1 Measurement settings)
  - User
  - ignition and combustion aid used

The drop-down list shows you all the ignition and combustion aids that have been created (Chapter 11.4.2 Ignition and combustion aids).
7. Specify the weight for every selected ignition and combustion aid. For specific energies the weight (g) is required, and this can be requested from the balance. The total energy of the ignition and combustion aid is automatically calculated and displayed under "Total". The calculated sum of all total energies is shown at the end of the input form.
8. When you have filled out all the obligatory fields, confirm what you have entered.



#### 11.5.2 Editing a measurement



### NOTE

Depending on the status of the measurement, the appropriate editing fields are displayed.

A simulation can be carried out without having selected a measurement.

If a calibration for C-value is used, it cannot be converted into a measurement.

1. Go to the "Measurement" menu.
2. To edit, select a measurement from the list and press **⌘**. Select:
  - Open
  - Print (only with active printer)
  - Export (with connected USB drive)
  - Evaluate (Chapter 11.4.6 Report)
  - Unselect
  - Multiple selection on/off
  - Simulation
  - Measurement <-> Calibration (a measurement is converted into a calibration and vice-versa).



### 11.5.3 Simulation

If a simulation is carried out with an existing measurement the values of the measurement are automatically entered in the simulation input form.

1. Go to the "Measurement" menu.
2. To edit, select the measurement from the list and press .
3. Select the simulation.
4. The values from the measurement are automatically adopted. Also enter the temperature increase (Delta T) and the ignition energy. During a simulated measurement you can change the user-defined C-value and during a calibration you can change the reference combustion value.
5. Confirm the inputs. The result is displayed in the measurement list.

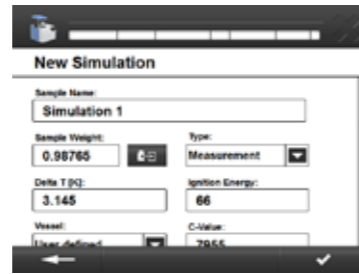

### 11.5.4 Starting a measurement

1. Go to the "Measurement" menu.
2. Select a created measurement.
3. Press  to start the measurement.



### Inserting a decomposition vessel

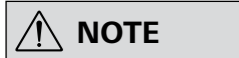

**Before inserting the decomposition vessel you must start the created measurement (Chapter 11.5.4 Starting a measurement).**

**Observe the requirements for the decomposition vessel (Chapter 11.2.1 Creating a decomposition vessel).**

**Follow the operating instructions for the decomposition vessel (C 6010/6012).**



1. Screw the decomposition vessel on finger-tight.
2. During automatic decomposition vessel detection you move the decomposition vessel over the sensor area. The RFID sensor (RFID: radio frequency identification) identifies the decomposition vessel. A beep sounds when detection has been successful.

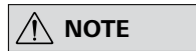

**If automatic decomposition vessel detection is deactivated this step is not carried out.**

3. Hang the decomposition vessel in the calorimeter cover.
4. Check if the decomposition vessel is safely closed and confirm the message. The decomposition vessel must be positioned centrally within the filling head of the inner cover. When it is correctly positioned you can feel it click home.
5. Start the measurement by confirming.



### 11.5.5 Measurement procedure

#### Graph view

Item	Function
A	Displays the current phase of the measurement
B	Displays information about the selected measurement (name, sample weight, name of the decomposition vessel, C-value of the decomposition vessel)
C	Progress bar for the current measurement
D	Cancel button to end the current measurement
E	Graph view shows the duration of the experiment and the temperature over time
F	Graph view
G	Detailed view of the measurement
H	Print measurement
I	Protocol view; shows the averaged temperature values (every 12 seconds) that are relevant to the result calculation of the calorific value.
J	Measurement information

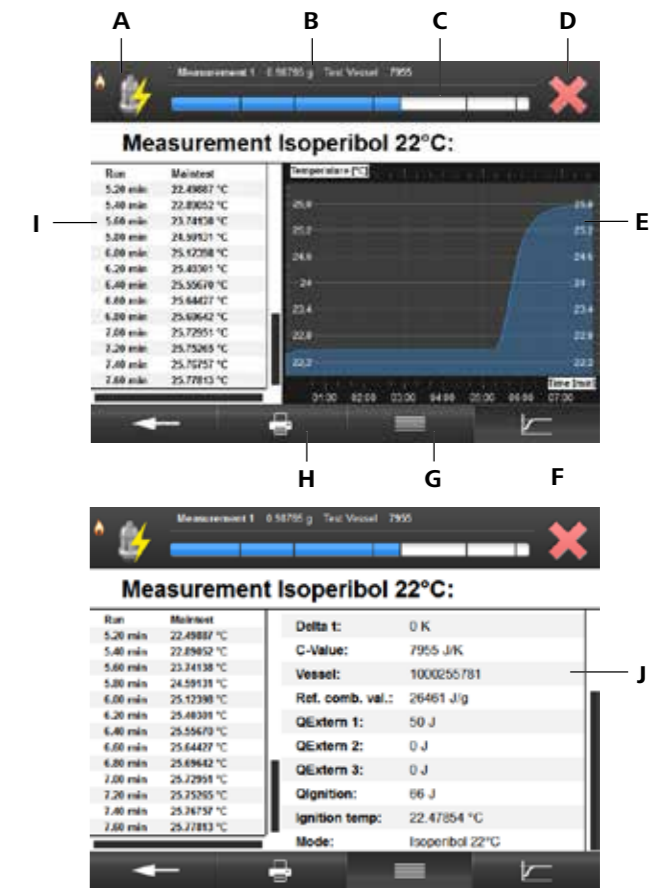

### 11.6 Archive

The archive shows all completed measurements in a list (Chapter 9.2 Status symbols). It is updated during the night.

#### 11.6.1 Selecting a measurement in the archive

You can filter completed measurements by time or name using a drop-down list.

1. Go to the "Archive" menu.
2. The list shows you all completed measurements. You can filter by time or name using the drop-down list . Select a field to do this.
3. Confirm the input.



#### 11.6.2 Editing a measurement in the archive



**Depending on the status of the measurement, the appropriate editing fields are displayed.**



1. To edit, select a measurement from the list and press .
2. Select:
  - Open
  - Print
  - Export (USB drive)
  - Evaluate (10.4.6 Report)
  - Unselect
  - Multiselection on/off





### 11.6.3 Opening a completed measurement

You can view the measurement data of a completed measurement. The units correspond to your settings.

1. To edit, select a measurement from the list and press .
2. Select "Open".
3. Press  to return to the list.



### 11.6.4 Evaluating a measurement

The Report corresponds to your settings (Chapter 11.4.6 Report)

1. To edit, select a measurement from the list and press .
2. Select "Evaluate".
3. You can use the drop-down list to select the page that is currently displayed (example based on Report DIN 51900):
  - Measurements: Displays the measurement data.
  - One or two input forms: Depending on the standard that has been set, different parameters must be entered.

**NOTE** The purpose and meaning of these parameters and the relevant calculation formulae for the complete results can be found in the respective standard.

- Result: Displays all of the parameters and results that are significant for the standard. The result can be printed and stored on this page.

**NOTE** Evaluations that have been saved or printed can no longer be changed.

4. Confirm the input.



## 11.7 Maintenance

Menu	Function
Maintenance programs	Opens the menu for selecting maintenance programs. Press  to reach the submenu.
Service	<b>NOTE</b> This is password-protected (Access only for authorised IKA maintenance staff).
Update software	Carry out software update
Update firmware	Carry out firmware update
Safely remove USB drive	Select this function before removing the USB drive (Fig. 1, 4a).
Empty Device	Start of the procedure-controlled emptying process of the water circuits. See the advice under Display (Chapter 12.1.3 Emptying water).
Factory Reset	The device will be reset to delivery state.

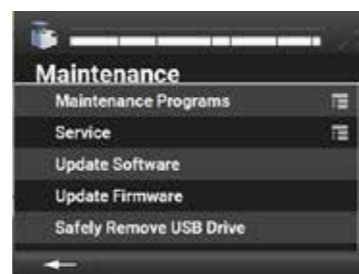

You can update your device using a USB drive (Fig. 1, 4a). For more information on the procedure see: <https://www.ika.com/fut>

### 11.7.1 Maintenance programs

**NOTE** You can select several programs. Ticking the box activates the menu item. Programs that are running are shown in blue. Programs shown in grey are inactive.

1. Go to the "Maintenance, Maintenance programs" menu.
2. Select the "Submenu" symbol.
3. Select one or more programs.
4. Go back to the menu using the arrow button. The programs start automatically.

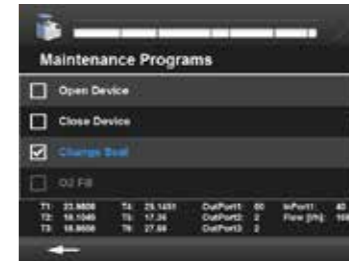

<b>Open Device</b>	Open the cover
<b>Close Device</b>	Close the cover
<b>Change Seal</b>	The O <sub>2</sub> filling piston goes down, so that the seal on the filling piston can be replaced. To this end the filling piston goes to its lowest position. Only possible when oxygen is connected.
<b>O<sub>2</sub> Fill</b>	An inserted decomposition vessel can be filled with oxygen manually (or control to see if oxygen flows out). End the maintenance program by selecting it again (changes from blue to grey).
<b>O<sub>2</sub> Degas</b>	An inserted decomposition vessel can be emptied manually. End the maintenance program by selecting it again (changes from blue to grey).
<b>Fill Water</b>	The inner vessel is filled with water manually. The device must be ready for operation. <b>NOTE</b> End the program (blue to grey), as the inflow is not switched off when the cover is open. As soon as the decomposition vessel has been inserted and the cover has been closed, the inflow from the device is switched off automatically.
<b>Empty Water</b>	The inner vessel is emptied. <b>NOTE</b> The run must be reset again manually. End the maintenance program by selecting it again (changes from blue to grey).
<b>RFID</b>	RFID detection: the decomposition vessel can be scanned and the internal RFID identification number is displayed.
<b>Stirrer</b>	Stirrer is switched on and the speed is displayed.
<b>Flow Inner Cycle</b>	Flow check in the inner water circuit. The flow is displayed.
<b>Flow Outer Cycle</b>	Flow check in the outer water circuit (condenser). The flow is displayed.

Item	Function
T1:	Inner vessel temperature
T2:	Outer vessel temperature
T3:	Heating temperature
T5:	Cooling water temperature
T6:	Ambient temperature
Out Port:	Switching state of the outputs
In Port 1:	Switching state of the outputs
Flow:	Current water flow

## 11.8 Information

The Information menu shows information about all devices.

### Version information:

Information on software and firmware, device serial numbers, PCB number (hardware information), manufacturing number.

### System logging:

System logging with information about the system for identifying faults.

### Device information and ignition counter:

Shows the total number of ignitions carried out with the device.

### Adjustment values

Displays the adjustment values for the different temperature ranges for adiabatic mode. Only for global standard devices.

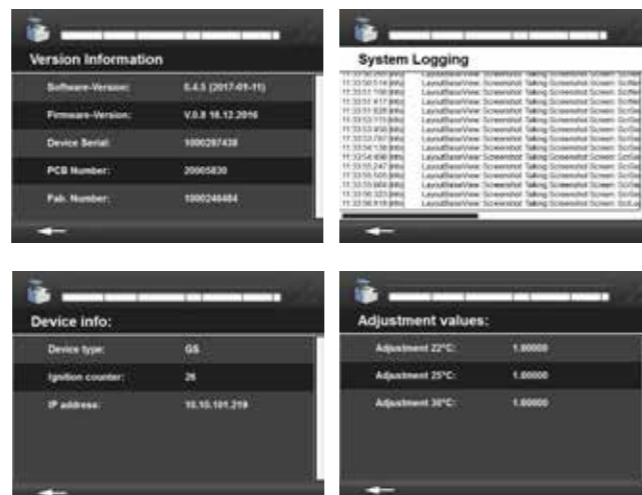

# 12 Maintenance and cleaning

## 12.1 Cleaning the system

### 12.1.1 Cleaning a decomposition vessel

After the trial has been recorded, you can take out the decomposition vessel, open it and clean it.

If you suspect that the combustion sample, the combustion gases produced or the combustion residue could be harmful to health, wear personal protective equipment (e.g. protective gloves, breathing masks) when handling these materials. Harmful or polluting combustion residue must be disposed of as hazardous waste. Express reference is made to the applicable regulations. In order to obtain accurate measurements it is essential that the inner wall of the decomposition vessel is clean and dry. Impurities alter the heat capacity of the decomposition vessel and thus cause inaccurate measuring results.

It is important to thoroughly clean the inner walls of the vessel, the internal fittings (brackets, electrodes etc.) and the combustion crucible (inside and out!) after each combustion test.

In most cases, you will only need to remove condensate from the inner walls of the vessel and the internal fittings. It is sufficient to thoroughly wipe the parts with an absorbent, non-fibrous cloth. If the decomposition vessel cannot be cleaned in the above way (e.g. due to baking, pitting, corrosion etc.), please contact the Technical Service.

The combustion residue in the crucible, e.g. soot or ashes, should also be wiped away with an absorbent non-fibrous cloth.

### 12.1.2 General maintenance and cleaning



**The water must be released from the device before it is transported.**

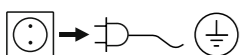

Remove the device from the mains before cleaning.

Only use cleaning agents recommended by **IKA**. Use the following cleaning agents to clean the following types of dirt:

Dirt	Cleaning agent
Dyes	Isopropyl alcohol
Building materials	Water containing detergent/isopropyl alcohol
Cosmetics	Water containing detergent/isopropyl alcohol
Food	Water containing detergent
Fuels	Water containing detergent

### Ordering spare parts

When ordering spare parts, please make sure to indicate the following:

- device type
- Device manufacturing number; see rating plate
- Software version (second value displayed when switching on the device)
- item number and description of spare part; see [www.ika.com](http://www.ika.com).

### Repairs

**Please only send devices in for repair that have been cleaned and are free of materials which might present health hazards.**

For this purpose request the form "Certificate of compliance" from **IKA**, or download and print the form from the **IKA** website [www.ika.com](http://www.ika.com).

If your appliance requires repair, return it in its original packaging. Storage packaging is not sufficient. also use appropriate transport packaging.

### 12.1.3 Emptying water

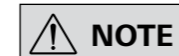

**NOTE**

The system messages guide you through the emptying process.

Please observe the chapters "Device configuration", "7.3 Scope of delivery" and "8 Installation and assembly".

1. Go to the "Maintenance" menu.
2. Select "Empty device".

### Preparation:

1. Switch off the condenser.
  2. Disconnect the hoses from the device (IN, OUT).
  3. Provide a vessel (approx. 1 L)
- ➔ Continue!

### Inner circuit OUT

1. Plug the discharge hose (Chapter 7.3 Scope of delivery) into EMPTY (Fig. 2, 12).
  2. Hold the end of the discharge hose in the vessel.
  3. Open the venting screw (Fig. 3, 18) anti-clockwise.
  4. Wait until the water flow stops (approx. 0.5 L).
  5. Close the venting screw (Fig. 3, 18) clockwise.
- ➔ Continue!

### Outer circuit IN

1. Plug the emptying aid (Chapter 7.3 Scope of delivery) into the IN inlet of the C 6000 (Fig. 2, 10).
  2. Hold the connected discharge hose EMPTY (Fig. 2, 12) in the vessel.
  3. Blow into the emptying aid with max. 0.5 bar compressed air.
  4. Wait until the water flow stops (approx. 0.1 L).
- ➔ Continue!

### Cooling circuit

1. Plug the discharge hose into the OUT outlet of the C 6000 (Fig. 2, 11).
  2. Hold the discharge hose in the vessel.
  3. Blow into the emptying aid with max. 0.5 bar compressed air.
  4. Wait until the water flow stops (approx. 0.25 L).
- ➔ Continue!

### Outer circuit OUT

1. Remove the emptying aid from the inlet IN of the C 6000.
  2. Plug the emptying aid into EMPTY (Fig. 2, 12).
  3. Hold the discharge hose in the vessel.
  4. Blow into the emptying aid with max. 0.5 bar compressed air.
  5. Wait until the water flow stops (approx. 0.02 L).
- ➔ Continue!

The C 6000 shuts down automatically. You can switch off the device.



## 12.2 Maintenance and cleaning of water filters

Check the filter every week or according to experience. Over time the filter becomes clogged with sludge thereby causing a reduction in the cooling water flow rate.

Cleaning the water filter (Fig. 2, 7):

1. Switch the C 6000 off.
2. Switch the cooling water supply off (switch off the condenser, turn off the tap).
3. Disconnect the hoses from the C 6000.
4. Have an absorbent cloth ready to hand.
5. Turn the filter casing anticlockwise with the filter spanner

(Chapter 7.3 Scope of delivery); some water will escape. Wipe up the water with the cloth.

6. Pull out the.
7. Use a suitable brush to clean the sieve inside and out.
8. Place the sieve back in the filter.
9. Screw the filter casing on finger-tight.
10. Reconnect the hoses to the C 6000 (Chapter 8.2 Fitting attachments).
11. Switch the cooling water supply on again.
12. Switch the C 6000 back on.

## 13 Error codes



### NOTE

Additional user messages may appear on the display during commissioning. Follow the instructions shown.

Proceed as follows:



1. Switch off the device using the device switch.
2. Take corrective measures
3. Restart the device



An error during operation is indicated by an error message on the display.

Once a serious error message has been displayed, the lift moves to the top end position and the device can no longer be operated.

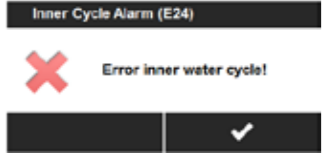
Display	Description	Cause	Solution
	<b>E01:</b> Wrong stirrer rotation speed!	This error appears if the target stirrer speed value is not reached.	This might be caused by a defective stirrer motor. Check the stir function using the maintenance menu.
	<b>E02:</b> Internal communication error	Appears when no internal communication between the software and the firmware is possible.	Switch device off and on
	<b>E03:</b> Drift criteria not reached!	This error message is generated during a measurement of the "Equalise" or "Main Test" status if the drift conditions for the current function of the C 6000 cannot be met.	Acknowledge the error message to revert to the "Wait" message. Switch to the "Servicing" tab and press the "Stirrer" button to check that the stirrer is working. Establish the specified ambient conditions. Perform an adjustment of the C 6000 in adiabatic mode.
	<b>E04:</b> No temperature raise detected after ignition!	This error message is generated, if the increase in temperature has not achieved the specified value within the first minute after ignition.	Acknowledge the error message to revert to the "Wait" message. Has the sample been combusted? The sample weight may be insufficient. The calorific value of the sample is too small, use a combustion aid. The oxygen pressure is too low. The stirrer is not working. The sample has not been combusted, despite the provision of an ignition thread: The ignition thread was blown away from the sample. The oxygen pressure is too low. Sample and ignition thread were not combusted: Check the ignition system.
	<b>E05:</b> System could not be filled during the predefined time	The system could not completely fill the inner vessel with water within a specified time period.	Acknowledge the error message to revert to the "Wait" message. Clean the water filter (Chapter 12.2). Water level in the condenser too low; water flow too low.
	<b>E07:</b> Temperature criteria for starting the measurement not reached	After 45 seconds at post-water filling status the current temperature is compared to the selected fill-water temperature. If is below the fill-water temperature, oxygen filling is started. Otherwise the system waits another 180 seconds, to see if the temperature falls below the fill-water temperature.	This problem may arise because the condenser temperature was set too high. Check the condenser. In the menu Maintenance, Maintenance programs, check the flow of the inner and outer circuits.

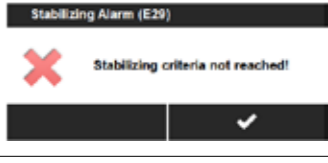
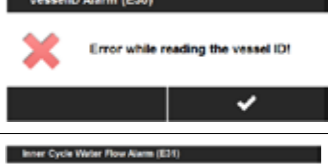
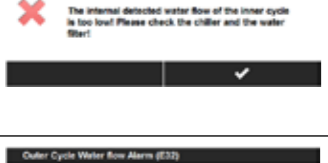
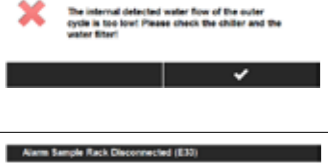
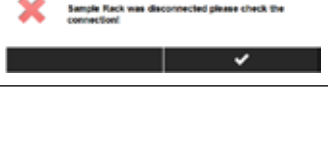
Display	Message	Cause	Solution
	<b>E09:</b> No ignition wire detected	No contact with the ignition wire	Check the ignition wire; tighten the nuts; replace the ignition wire (Operating instructions C6010/12). Clean the ignition contacts (inner vessel, inner cover). Check the spring contact.
	<b>E10:</b> Upper water sensor reacts too soon	The water sensor shows completely full within a very short time.	Acknowledge the error message to revert to the "Wait" message. Check whether a drip is hanging from the water sensor. Blow out the recess around the water sensor.
	<b>E11:</b> Error while closing device cover! Please check the vessel or ignition wire!	a. The cover did not reach the lower cover contact. b. The ignition contact did not close. c. Check whether a drip is hanging from the water sensor.	Acknowledge the error message to revert to the "Wait" message. a. Contact the service department. b. No decomposition vessel hung in the cover; ignition circuit interrupted. c. Blow out the recess around the water sensor.
	<b>E14:</b> Temperature sensor at upper limit!	Temperature sensor shows temperatures above 55 °C	Switch device off and on
	<b>E15:</b> Temperature sensor at lower limit!	Temperature sensor shows temperatures under 5 °C	Switch device off and on
	<b>E20:</b> No heat pulse in inner water cycle!	No increase in temperature within the inner water circuit.	Acknowledge the alarm. Check the cooling water flow Check the circulating pump. Click "Restart" to repeat the system test.
	<b>E21:</b> No heat pulse in outer water cycle!	No increase in temperature within the outer water circuit.	Acknowledge the alarm. Check the cooling water flow Check the condenser and the water inflow. Click "Restart" to repeat the system test.
	<b>E22:</b> Error converter!	High-precision temperature measurement is one of the core functionalities of the calorimeter. Any error message regarding the temperature recording brings the current measurement to an end and demands a system test. Further work using the calorimeter can be performed only once the system test has been completed successfully.	Acknowledge the error message in order to switch to the "System Check" status. Press the "Restart" button". The temperature converter is reset and the system test starts. On successful completion the status switches to "Wait". If the system test was unsuccessful, switch the C 6000 off and on again. If the system test is unsuccessful again, please contact IKA Service department.

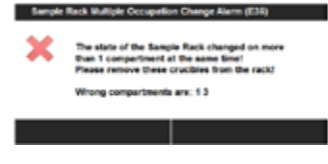
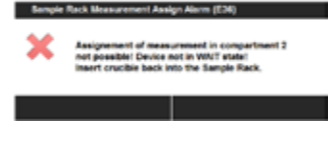
Display	Message	Cause	Remedial action
	<b>E23:</b> Error regulator!	The reliable regulation of the outer vessel is a major precondition for good quality measured values. Any error message regarding the regulator brings the current measurement to an end and demands a system test. Further work using the calorimeter can be performed only once the system test has been completed successfully.	Acknowledge the error message in order to switch to the "System Check" status. Press the "Restart" button". The temperature converter and the controller are reset and the system test starts. On successful completion the status switches to "Wait". If the system test was unsuccessful, switch the C 6000 off and on again. If the system test is unsuccessful again, please contact <b>IKA</b> Service department.
	<b>E24:</b> Error inner water cycle!	The stability criterion for the regulation of the water circuits to the working temperature was not achieved within the specified period of time.	Acknowledge the error message to revert to the "Wait" message. Check the water circuit. Check the heating. We recommend performing a system test to localise more precisely the cause of the problem.
	<b>E26:</b> Error run mode check!	The selected function cannot be used because the temperature of the cooling water has not reached the required values.	Select another working mode. Change the condenser temperature. Check the condenser and the water inflow. Restart the system test.
	<b>E29:</b> Stabilizing criteria not reached!	Stability criterion not achieved during a measurement (time criterion).	If this occurs repeatedly contact the Service department.
	<b>E30:</b> Error while reading the vessel ID!	The RFID sensor could not be read properly.	Confirm the message and scan again. If this occurs repeatedly contact the Service department.
	<b>E31:</b> The internal detected water flow of the inner cycle is too low! Please check the chiller and the water filter!	There are air bubbles in the inner circuit, which are reducing the pump performance.	Start the maintenance program (Chapter 11.7.1) "Flow Outer Cycle".
	<b>E32:</b> The internal detected water flow of the outer cycle is too low! Please check the chiller and the water filter!	The internal detected water flow of the outer cycle is too low!	Please check the chiller and the water filter!
	<b>E33:</b> Sample rack was disconnected please check the connection.	No connection to the sample rack.	Check if the sample rack is plugged in.

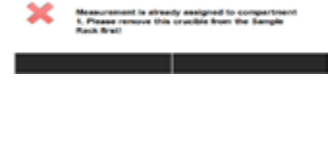
Display	Message	Cause	Remedial action
	<b>E34:</b> Invalid initial sample rack occupation. Measurements prepared for sample rack compartments 4 5 not found! And for sample rack compartments 1 and 3 no measurement found. Remove all crucibles from the sample rack and reset the occupation.	When activating the sample rack an assignment was found that no longer corresponds to the saved assignment.	Remove all crucibles from the sample rack and reset the occupation.
	<b>E35:</b> The status of the Sample Rack has changed in more than one compartment at the same time! Please remove these crucibles from the rack! Wrong compartments are: 1 3.	Several crucibles were placed in the sample rack at the same time.	Remove crucibles from the specified compartments.
	<b>E36:</b> Assignment of measurement in compartment 2 not possible! Device not in WAIT state. Insert crucible back into the Sample Rack.	The device was not in wait mode when the crucible was taken out of the rack.	Put the crucible back in the compartment and wait until the device is in wait mode.
	<b>E37:</b> Please remove the crucible from Sample Rack compartment 3.	If a measurement is assigned to a crucible in the sample rack but this measurement is deleted or aborted, the crucible must be removed from the sample rack.	Please remove the crucible from Sample Rack compartment 3.
	<b>E38:</b> Measurement is already assigned to compartment 1. Please remove this crucible from the sample Rack first.	If a second crucible is assigned when a measurement is created, this message appears.	Remove the crucible that you have just put into the sample rack. To assign a new crucible to the measurement, remove the crucible from compartment 1.

In the event that the fault cannot be eliminated using the measures described or another error code is displayed:

- please contact the Service department,
- send the device and a detailed description of the fault.

## 14 Accessories and consumables

### 14.1 Accessories

C 6010	Decomposition vessel	C 27	Calorimeter instrument set
C 6012	Decomposition vessel, halogen-resistant	C 5041.10	Connecting cable 9-pin/3 m
C 5010.5	Crucible holder, large	C 6040	Calwin
C 5010.8	Crucible holder, small	C 1.50	Dot-matrix printer
C 21	Pelleting press	C 60.1020	Organiser
C 5020	Sample rack	C 25	Pressure reducer
C 29	Pressure reducer, oxygen		
C 6030	Venting station		

### 14.2 Consumables

C 723	Benzoic acid blister pack, 50 x	C 1.103	Ignition wire
C 723	Benzoic acid big pack	C 1.123	Ignition wire, platinum
C 43	Benzoic acid NIST 39i	C 14	Combustible crucible (100 x)
C 710.4	Cotton wool threads, cut to length	C 5 VA	Combustion crucible set (25 x)
C 710.8	Cotton wool threads, cut to length, thick	C 710.2 VA	Combustion crucible (25 x)
C 16	Parafilm 1000 x 50 mm	C 4	Quartz dish
C 17	Paraffin, liquid, 30 ml	C 6	Quartz dish, large
C 15	Paraffin strips, 600 x/pack	C 6000.10	Spare part set for C 6000/C 6010
C 9	Gelatine capsules (100 x)	C 6000.12	Spare part set for C 6000/C 6012
C 10	Acetobutyrate capsules (100 x)	C 6000.1	Waterprotect
C 12 A	Combustion bag, 70 x 40 mm (100 x)		
C 12	Combustion bag, 40 x 35 mm (100 x)		
AOD 1.11	Control standard for sulphur and chlorine		
AOD 1.12	Control standard for fluorine and bromine		

For further accessories see [www.ika.com](http://www.ika.com)

## 15 Technical data

		IKA C 6000 global standards	IKA C 6000 isoperibol
Measuring range max.	<b>J</b>	40000	
Measuring mode adiabatic 22 °C		yes	-
Measuring mode dynamic 22 °C		yes	
Measuring mode isoperibol 22 °C		yes	
Measuring mode adiabatic 25 °C		yes	-
Measuring mode dynamic 25 °C		yes	
Measuring mode isoperibol 25 °C		yes	
Measuring mode adiabatic 30 °C		yes	-
Measuring mode dynamic 30 °C		yes	
Measuring mode isoperibol 30 °C		yes	
Measurements/hour adiabatic		5	-
Measurements/hour dynamic		6	
Measurements/hour isoperibol		4	
Reproducibility adiabatic (1 g benzoic acid NBS39i)	<b>%RSD</b>	0.05	-
Reproducibility dynamic (1 g benzoic acid NBS39i)	<b>%RSD</b>	0.15	
Reproducibility isoperibol (1 g benzoic acid NBS39i)	<b>%RSD</b>	0.05	
Touch screen		yes	
Working temperature min.	<b>°C</b>	22	
Working temperature max.	<b>°C</b>	30	
Temperature measurement resolution	<b>K</b>	0.0001	
Cooling medium temperature min.	<b>°C</b>	12	
Cooling medium temperature max.	<b>°C</b>	27	
Cooling medium permissible Operating pressure	<b>bar</b>	1.5	
Cooling medium		Tap water of drinking quality	
Type of cooling		Flow	
Condenser		RC 2 basic	
Flow rate min.	<b>L/h</b>	60	
Flow rate max.	<b>L/h</b>	70	
Recommended flow rate at 18 °C	<b>L/h</b>	60	
Oxygen operating pressure max.	<b>bar</b>	40	
Interface to balance		RS 232	
Interface to printer		USB	
Interface to PC		RS 232	
Interface to sample rack		yes	
Interface to ext. keyboard		yes	
Oxygen filling		yes	
Degassing		yes	
Decomposition vessel detection		yes	
Decomposition vessel C 6010		yes	
Decomposition vessel C 6012		yes	
Evaluation as per DIN 51900		yes	
Evaluation as per DIN EN ISO 1716		yes	
Evaluation as per DIN EN ISO 9831		yes	

		<b>IKA C 6000 global standards</b>	<b>IKA C 6000 isoberibol</b>
Evaluation as per DIN EN 15170			yes
Evaluation as per DIN EN 14918			yes
Evaluation as per ASTM D240			yes
Evaluation as per ASTM D4809			yes
Evaluation as per ASTM D1989		-	yes
Evaluation as per ASTM D5865			yes
Evaluation as per ASTM E711			yes
Evaluation as per ISO 1928			yes
Evaluation as per BG T213			yes
Width	<b>mm</b>		500
Depth	<b>mm</b>		450
Height	<b>mm</b>		425
Weight	<b>kg</b>		29
Permitted ambient temperature min.	<b>°C</b>		20
Permitted ambient temperature max.	<b>°C</b>		30
Permissible relative humidity	<b>%</b>		80
Protection class according to DIN EN 60529			IP 20
RS 232 interface			yes
USB interface			yes
Voltage	<b>V</b>		220-240
Frequency	<b>Hz</b>		50/60
Power consumption	<b>W</b>		1700
Permitted transport temperature min.	<b>°C</b>		20
Permitted transport temperature max.	<b>°C</b>		60
Permitted storage temperature min.	<b>°C</b>		5
Permitted storage temperature max.	<b>°C</b>		60
Protection class			I
Overvoltage category			II
Degree of contamination			2
Use above max. sea level	<b>m</b>		2000
Protection at overload			yes
Firmware update			yes

*Subject to technical changes!*

# IKA

designed for scientists

---

## **IKA-Werke GmbH & Co. KG**

Janke & Kunkel-Straße 10, 79219 Staufen, Germany

Phone: +49 7633 831-0, Fax: +49 7633 831-98

eMail: sales@ika.de

---

### **USA**

**IKA Works, Inc.**

Phone: +1 910 452-7059

eMail: usa@ika.net

### **KOREA**

**IKA Korea Ltd.**

Phone: +82 2 2136 6800

eMail: sales-lab@ika.kr

### **BRAZIL**

**IKA Brasil**

Phone: +55 19 3772 9600

eMail: sales@ika.net.br

### **MALAYSIA**

**IKA Works (Asia) Sdn Bhd**

Phone: +60 3 6099-5666

eMail: sales.lab@ika.my

### **CHINA**

**IKA Works Guangzhou**

Phone: +86 20 8222 6771

eMail: info@ika.cn

### **POLAND**

**IKA Poland Sp. z o.o.**

Phone: +48 22 201 99 79

eMail: sales.poland@ika.com

### **JAPAN**

**IKA Japan K.K.**

Phone: +81 6 6730 6781

eMail: info\_japan@ika.ne.jp

### **INDIA**

**IKA India Private Limited**

Phone: +91 80 26253 900

eMail: info@ika.in

### **UNITED KINGDOM**

**IKA England LTD.**

Phone: +44 1865 986 162

eMail: sales.england@ika.com

### **VIETNAM**

**IKA Vietnam Company Limited**

Phone: +84 28 38202142

eMail: sales.lab-vietnam@ika.com

---

Discover and order the fascinating products of IKA online:  
**[www.ika.com](http://www.ika.com)**



IKAworlwide



IKAworlwide /// #lookattheblue



@IKAworlwide

---

Technical specifications may be changed without prior notice.